



*happiness
for a life time*



*Modular Kitchen Accessories
Hardware & Fittings*





FEDER

*happiness
for a life time*

Feder - A leading Manufacturer and Trader into the verticals of Modular Kitchen Accessories and Hardware Fittings with a unique experience of giving you the extreme edge of captivating the unexplored spaces of your kitchen, with utmost ease and comfort. Conceptualised & designed as per European Standards, Feder has a foot print all over the Middle East & European B2B businesses and now, is foraying into Indian Markets to deliver the smooth, durable and perfect kitchen hardware and accessories. The product line is highly appreciated across the users, as we play alongside the pioneers of the domain. We own the expertise to provide solutions to every aspect of Modular Kitchens and its Hard

ware, be it a storage rack, pull out or an elegant cutlery shelf, be it anything in your kitchen hardware. The accessories are made available to suit all moods of home & kitchen decors in the Indian market. The modern day Feder storage solutions are highly compatible and efficient to harness the

space to the best extent.









Some of our speciality focused products happen to be :

- Soft Close Drawer System
- Tall Unit
- Pantry Units
- Corner Solution
- Waste Bins
- Cutlery Organizers
- and many more to suit your needs

Entire range of Feder, are like thoughts born with a boon to flaunt the user, leaving them amused and in total Awe. Equipped with eminent & efficient design and best quality hardware to live up to your beautiful imagination, your interior requirements and there in transform the available space from dream to reality. The perfect kitchen will come together when you choose the right ingredient, the right flavor from our exquisite range of Modular solutions at Feder India. The edge with Feder happens to be lying, in the product range which is economically priced and clubbed with a state of the art product line, equipped with long lasting hardware & accessories "for a life time experience."



ACCESSORIES

PRODUCT	SPECIFICATION	PRODUCT CODE	PAGE NO
	Arena Style Lemans	FED-SWG	1-2
	Arena Style Magic Corner	FED-MCR	3-4
	Arena Style Universal Magic Corner	FED-SHC	5-6
	Arena Style Convay Unit	FED-CPO	7-8
	Arena Style Pantry Pull Out	FED-PPO	9-12
	Arena Style Mul Basket	FED-MBT	13-14
	Arena Style Kitchen Gud Mul Basket	FED-GMB	15-16
	Arena Style Side Tray Basket	FED-SPO	17-18
	DETERGENT PULL OUT	FED-DPO	19-20



ACCESSORIES

PRODUCT	SPECIFICATION	PRODUCT CODE	PAGE NO
	Pull Out Waste Bin	FED-WB	21-22
	SS Waste Bin	FED-WB	23-24
	Rice Box Pull Out	FED-RB	25-26
	Divider	FTB - DW	107
	Plate Holder	F-PHG	108
	SS Box Cutlery	F.CUT	109-110
	PVC Cutlery	F.PCT	111
	Anti Skid Mat	F-ASM	112
	Quodro Channel	F-BQ	113
	Slow motion Hinges	F-3D	114





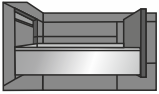
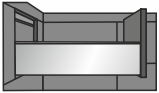
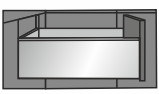
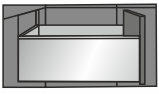
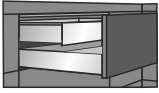
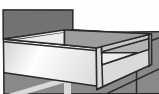
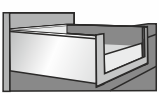
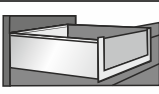
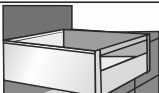
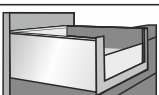
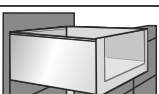







SLIM DRAWER

PRODUCT	SPECIFICATION	PRODUCT CODE	PAGE NO
	Standard Drawer 84 mm	FSD - 84 - 01	29-30
	High Drawer 116 mm	FSD - 116 - 02	31-32
	High Drawer 167 mm	FSD - 167 - 03	33-34
	High Drawer 199 mm	FSD - 199 - 04	35-36
	Standard Drawer 84 mm with Dye cut for inner front panel	FISD - 84 - 05	37-38
	High inner Drawer 167 mm with Inner heightened Railing Dye cut for inner front panel	FISD - 167 - 06	39-40
	High inner Drawer 167 mm with Inner heightened Railing Dye cut for inner front panel	FISD - 167 - 07	41-42
	High inner Drawer 167 mm with Inner heightened Railing Dye cut for inner front panel	FISD - 167 - 08	43-44
	High inner Drawer 199 mm with Inner heightened Railing Dye cut for inner front panel	FISD - 199 - 09	45-46
	High inner Drawer 199 mm with Inner heightened Railing Dye cut for inner front panel	FISD - 199 - 10	47-48
	High inner Drawer 199 mm with Inner heightened Railing Dye cut for inner front panel	FISD - 199 - 11	49-50



TANDEM DRAWER

PRODUCT	SPECIFICATION	PRODUCT CODE	PAGE NO
	Tandem Double Wall Drawer 84 mm	FTB - 84 - 12	55-56
	Tandem Double Wall Drawer With extended single square side rails 151 mm	FTB - 84 - 13	57-58
	Tandem Double Wall Drawer With extended single square side rails 183 mm	FTB - 84 - 14	59-60
	Tandem Double Wall Drawer With extended Double square side rails 183 mm	FTB - 84 - 15	61-62
	Tandem Double Wall Drawer Slide With extended side Glass 151mm	FTB - 84 - 16	63-64
	Tandem Double Wall Drawer Slide With extended side Glass 183 mm	FTB - 84 - 17	65-66
	Tandem Double Wall Drawer Slide With extended Inner Front Panel 84 mm	FITB - 84 - 18	67-68
	Tandem Double Wall Drawer Slide With Inner Side Glass Front Panel & Square bar 151mm	FITB - 84 - 19	69-70
	Tandem Double Wall Drawer Slide With Inner Side Glass Front Panel & Square bar 183 mm	FITB - 84 - 20	71-72
	Tandem Under Sink Drawer	FTB - 84 - 21	73-74



KLASS DRAWER

Coming
Soon

PRODUCT	SPECIFICATION	PRODUCT CODE	PAGE NO
	Klass Drawer Slide Height 84mm	KDS - 84 - 22	81-82
	Klass Drawer Slide Height 167mm	KDS - 167-23	83-84
	Klass Drawer Slide Height 199mm	KDS - 199 - 24	85-86
	Klass Drawer Slide With Inner Front Panel & Full Glass Height 84 mm	KID - 84 - 25	87-88
	Klass Drawer Slide With Inner Front Panel Height 84mm	KID - 84 - 26	89-90
	Klass Drawer Slide with Inner Front Panel & Square bar Height 167mm	KID - 167 - 27	91-92
	Klass Drawer Slide with Inner Front Panel & Half Glass Height 167mm	KID - 167 - 28	93-94
	Klass Drawer Slide With Inner Front Panel & Full Glass Height 167mm	KISD-167-29	95-96
	Klass Drawer Slide with Inner Front Panel & Square bar Height 199mm	KISD - 199 - 30	97-98
	Klass Drawer Slide with Inner Front Panel & Half Glass Height 199mm	KISD - 199 - 31	99-100
	Klass Drawer Slide With Inner Front Panel & Full Glass Height 199mm	KISD - 199 - 32	101-102



Arena Style 900 - Leamans



Left opening

Right opening

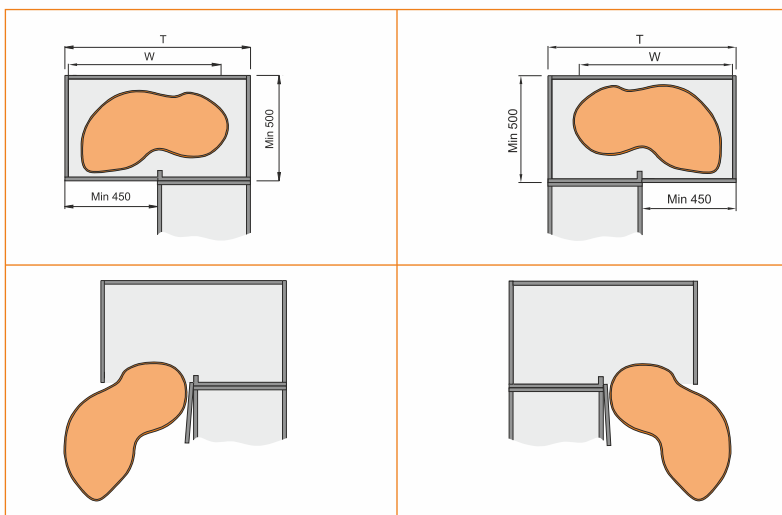

Arena Style 900 - Leamans

Art. No.	Cabinet (T)	Width x Depth x Height	Description
FED-SWG-11	900 mm	785x475x(600-730) mm	Left opening
FED-SWG-12	900 mm	785x475x(600-730) mm	Right opening



Soft Close

Arena Style - Magic Corner



Left opening

Right opening

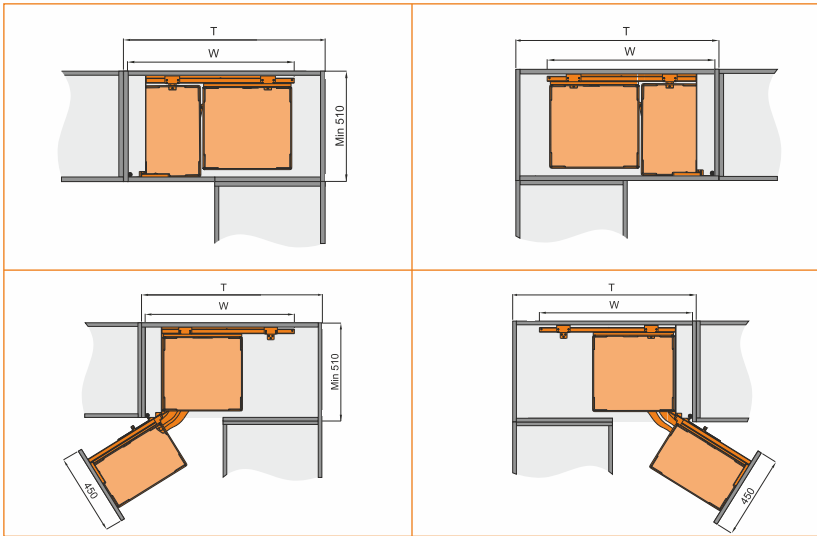

Arena Style - Magic Corner

Art. No.	Cabinet (T)	Width x Depth x Height	Description
FED - MCR - 21	900 mm	860x510x(620-750) mm	Left opening
FED - MCR - 22	900 mm	860x510x(620-750) mm	Right opening



Soft Close

Arena Style - Universal Magic Corner



Universal.

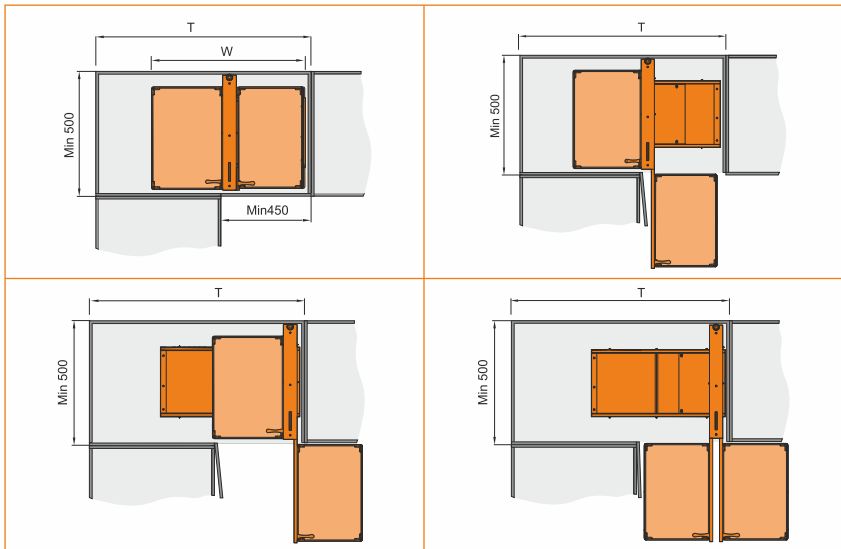

Arena Style - Universal Magic Corner

Art. No.	Cabinet (T)	Width x Depth x Height	Description
FED - SHC - 23	800 mm	670x455x595 mm	Left or right is same one

Larder Units



Soft Close

Arena Style - Convoy Unit

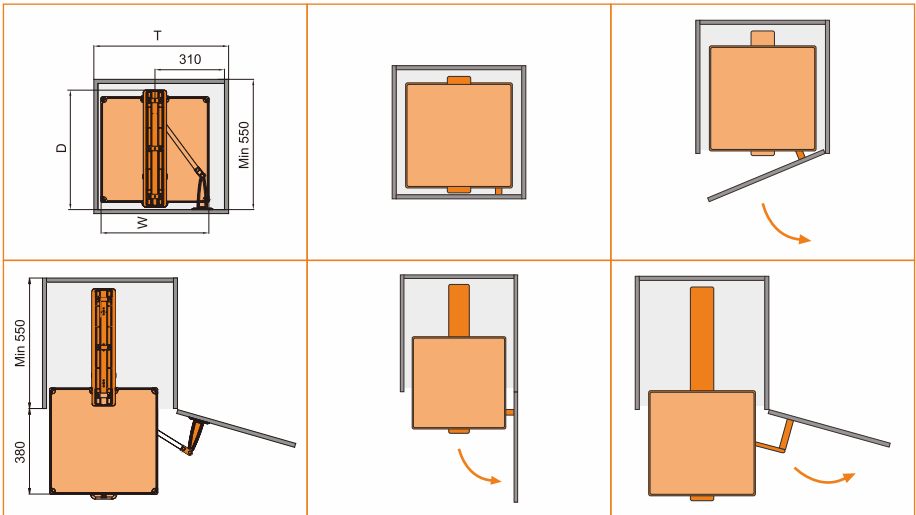

Arena Style - Convoy Unit

Art. No.	Cabinet (T)	Width x Depth x Height	Description
FED - CPO - 33	500 mm	380X535X(2020-2320)mm	5 Layers
FED - CPO - 34	600 mm	480X535X(2020-2320)mm	5 Layers



Arena Style - Pantry Pull-Out

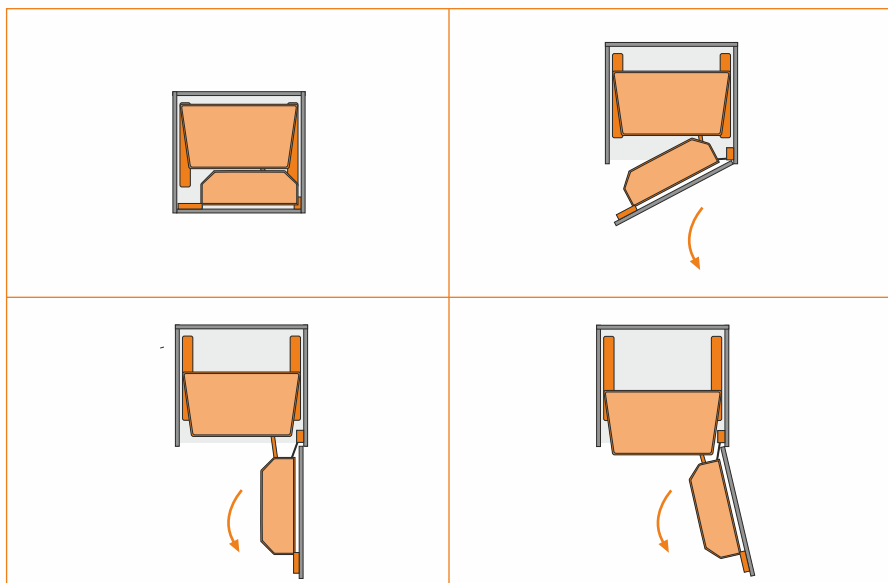



Arena Style - Pantry Pull-Out

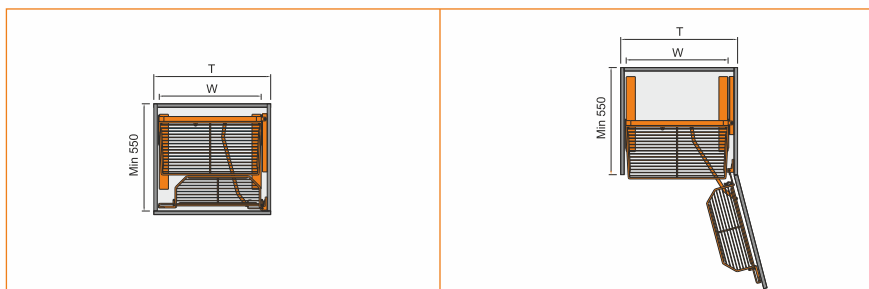

Arena Style - Pantry Pull-Out

Art. No.	Cabinet (T)	Width x Depth x Height	Description
FED - PPO - 31	450/500 mm	414X500X1820 mm	6 Layers
FED - PPO - 32	600 mm	564X500X1820 mm	6 Layers



Soft Close

Arena Style - Mul Basket

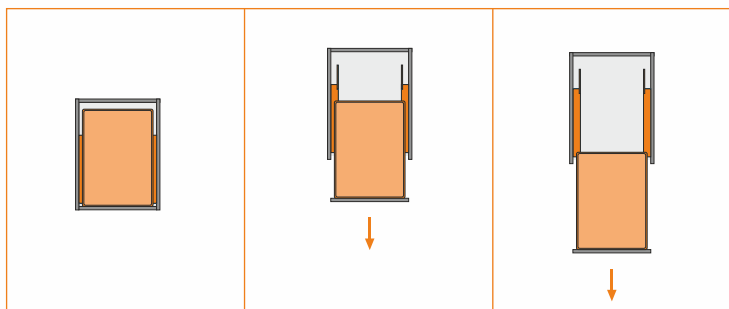
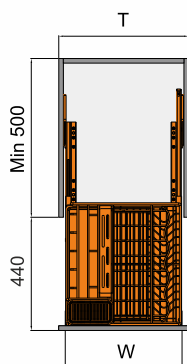

Arena Style - Mul Basket

Art. No.	Cabinet	Width x Depth x Height	Description
FED - MBT - 41	450 mm	397X450X470 mm	-----



Soft Close

Arena Style - Kitchen Gud Mul Basket

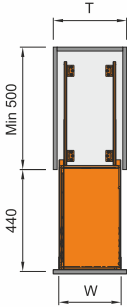

Arena Style - Kitchen Gud Mul Basket

Art. No.	Cabinet	Width x Depth x Height	Description
FED -GMB - 42	300 mm	250X465X520 mm	-----



Soft Close

Arena Style - Side Tray Basket

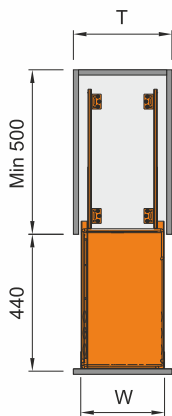

Arena Style - Side Tray Basket

Art. No.	Cabinet	Width x Depth x Height	Description
FED - SPO - 51	200 mm	135X460X550 mm	2 Layers
FED - SPO - 52	300 mm	234X460X550 mm	2 Layers



Soft Close

Detergent Pull Out

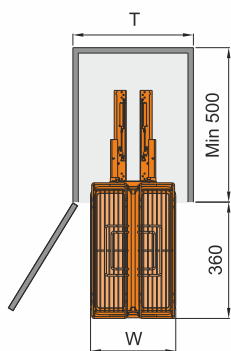

Detergent Pull Out

Art. No.	Cabinet (T)	Width x Depth x Height	Description
FED - DPO - 43	350 mm	270X470X320 mm	-----

Base Units



Soft Close

Pull Out Waste Bin

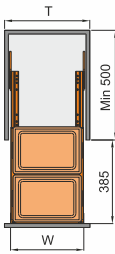

Pull Out Waste Bin

Art. No.	Cabinet (T)	Width x Depth x Height	Description
FED - WB - 01	400 mm	345X475X440 mm	2 Barrels and Link the door, 20L each box



SS Waste Bin

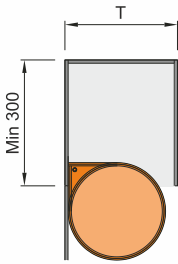

SS Waste Bin

Art. No.	Cabinet (T)	Width x Depth x Height	Description
FEB - WB - 02	400 mm	Φ290xH350 mm	14L



Rice - Box Pull Out

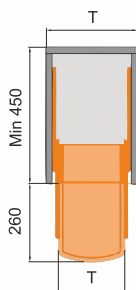

Rice - Box Pull Out

Art. No.	Cabinet (T)	Width x Depth x Height	Description
FED - RB - 51	350 mm	290x390x480 mm	-----





Slim wall double wall drawer slide height 84mm

FSD - 84 - 01 Loading Capacity 40 kgs



Luxury, Silence, Smooth, Soft closing, Full extension. New safety device to prevent drawer fall out. Heavy-duty, useful life more than 80,000 times. Easy to take drawer out and put it on. Easy for consumer to clear the drawer.

Various sizes and components available to meet different consumer's requirement.

Up & down 4mm adjustable, left & right 3mm adjustable.

Length: 350 / 400 / 450 / 500 / 550 mm.

Product Information

Space Required

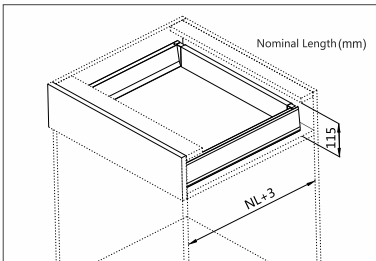

Components View

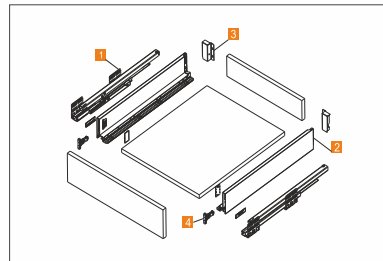

1		Drawer slide L/R
		Loading Capacity 40 Kg
	FSD - 84	350 / 400 / 450 / 500 / 550 mm

2		Decorative Covers L/R
	FSD-84-02	350 / 400 / 450 / 500 / 550 mm
	Colour	White / Grey

3		Rear Connectors L/R
	FSD - RC - 11	White / Grey

4		Front Connectors
	FSD - FC - 01	

SLIM DRAWER

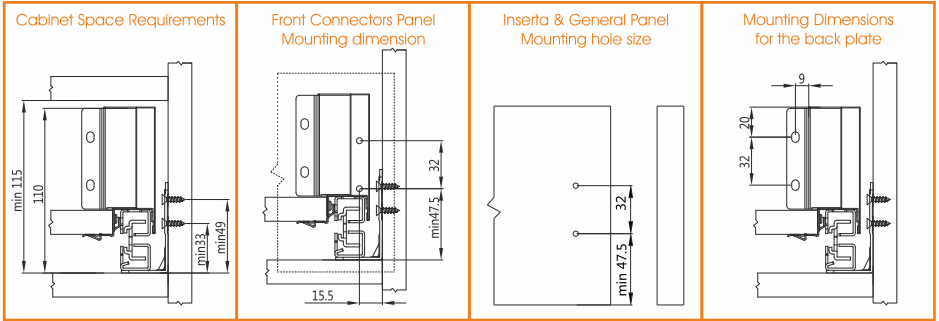

The drawer runners mounting dimensions

Nominal Length (mm)

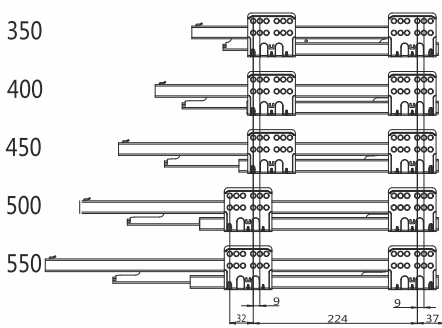

Rail mounting hole distance

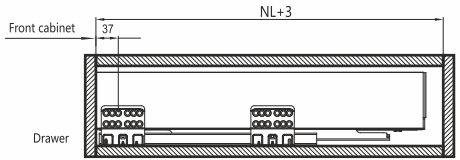

Cutting Dimensions for 16mm - thick

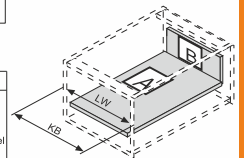
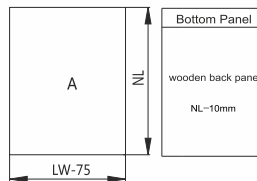
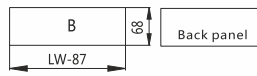

KB Cabinet width
 LW Internal cabinet width
 NL Normal Length

Slim wall double wall drawer slide height 116mm

FSD - 116 - 02 Loading Capacity 40 kgs



Luxury, Silence, Smooth, Soft closing, Full extension. New safety device to prevent drawer fall out. Heavy-duty, useful life more than 80,000 times. Easy to take drawer out and put it on. Easy for consumer to clear the drawer.

Various sizes and components available to meet different consumer's requirement.

Up & down 4mm adjustable, left & right 3mm adjustable.

Length: 350 / 400 / 450 / 500 / 550 mm.

Product Information

Space Required

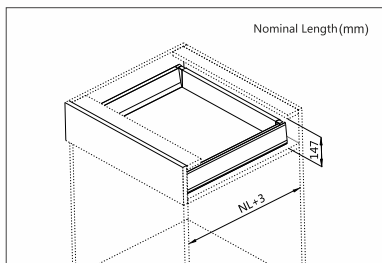

Components View

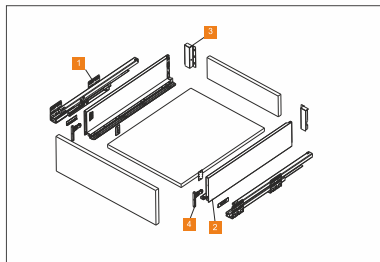

1		Drawer slide L/R	FSD - 116	350 / 400 / 450 / 500 / 550 mm
		Loading Capacity 40 Kg		
2		Decorative Covers L/R	FSD - 116-03	350 / 400 / 450 / 500 / 550 mm
		Colour	White / Grey	
3		Rear Connectors L/R	FSD - RC - 12	White / Grey
4		Front Connectors	FSD - FC - 02	

SLIM DRAWER

Cabinet Space Requirements

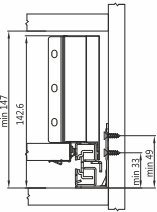

Front Connectors Panel Mounting dimension

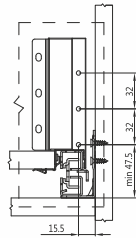

Inserta & General Panel Mounting hole size

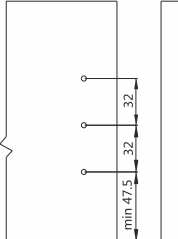

Mounting Dimensions for the back plate

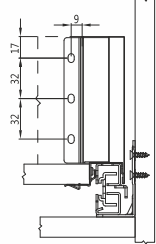

The drawer runners mounting dimensions

Nominal Length (mm)

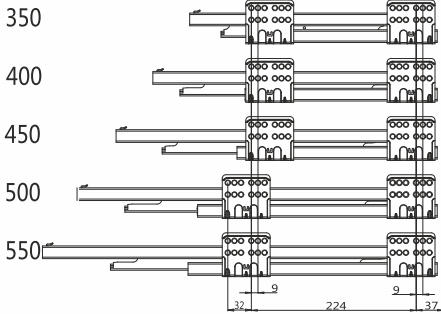

Rail mounting hole distance

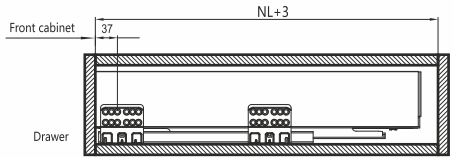

Cutting Dimensions for 16mm - thick MDF

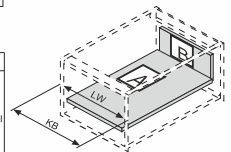
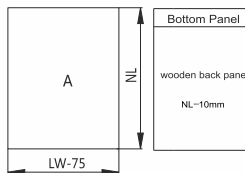
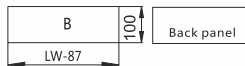

KB Cabinet width
LW Internal cabinet width
NL Normal Length

Slim wall double wall drawer slide height 167mm

FSD - 167 - 03 Loading Capacity 40 kgs



Luxury, Silence, Smooth, Soft closing, Full extension. New safety device to prevent drawer fall out. Heavy-duty, useful life more than 80,000 times. Easy to take drawer out and put it on. Easy for consumer to clear the drawer.

Various sizes and components available to meet different consumer's requirement.

Up & down 4mm adjustable, left & right 3mm adjustable.

Length: 350 / 400 / 450 / 500 / 550 mm.

Product Information

Space Required

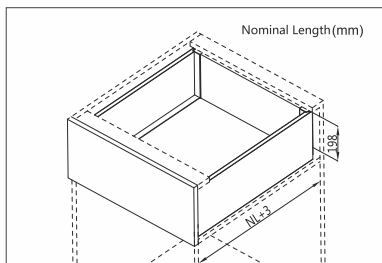

Components View

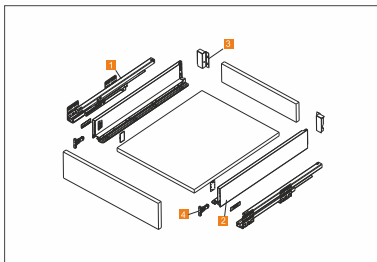

1		Drawer slide L/R
		Loading Capacity 40 Kg
FSD - 167		350 / 400 / 450 / 500 / 550 mm

2		Decorative Covers L/R
		FSD - 167-04
	Colour	White / Grey

3		Rear Connectors L/R
		FSD - RC - 13
	White / Grey	

4		Front Connectors
		FSD - FC - 03

SLIM DRAWER

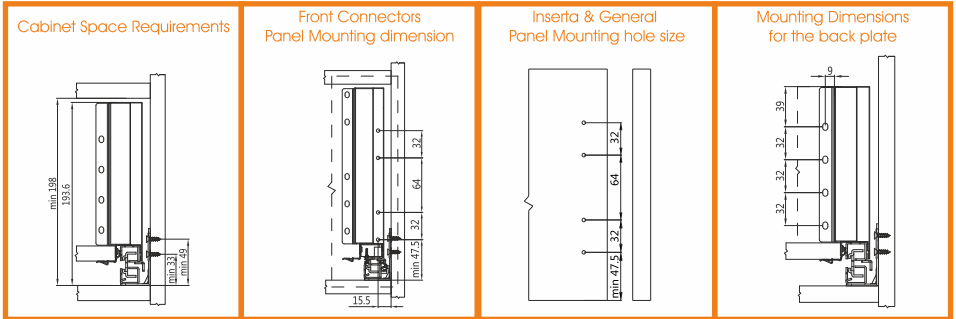

The drawer runners mounting dimensions

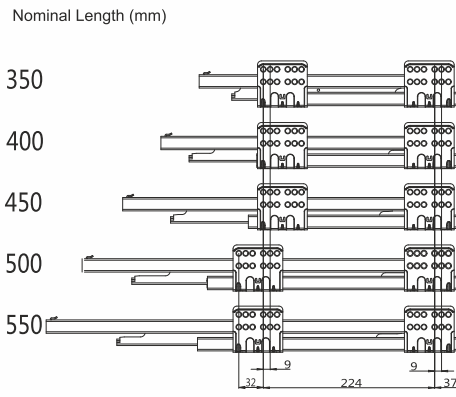

Rail mounting hole distance

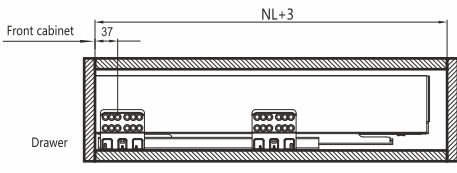

Cutting Dimensions for 16mm - thick MDF

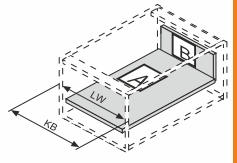
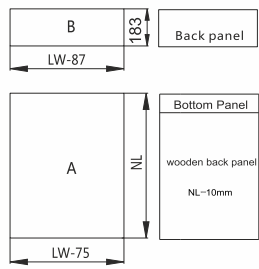

KB Cabinet width
 LW Internal cabinet width
 NL Normal Length

Slim wall double wall drawer slide height 199mm

FSD -199 - 04 Loading Capacity 40 kgs



Luxury, Silence, Smooth, Soft closing, Full extension. New safety device to prevent drawer fall out. Heavy-duty, useful life more than 80,000 times. Easy to take drawer out and put it on. Easy for consumer to clear the drawer.

Various sizes and components available to meet different consumer's requirement.

Up & down 4mm adjustable, left & right 3mm adjustable.

Length: 450 / 500 / 550 mm.

Space Required - M

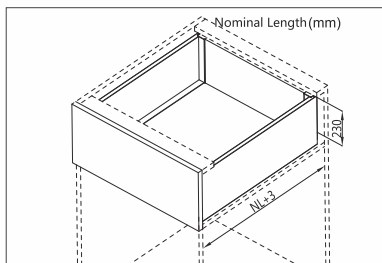

Components View

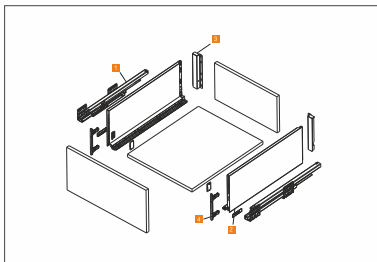

1		Drawer Runners L/R
		Loading Capacity 40 Kg
FSD - 199		450 / 500 / 550 mm

2		Drawer slides Decorative Covers L/R
		FSD - 199-05
		450 / 500 / 550 mm
	Colour	White / Grey

3		Rear Connectors L/R
		FSD - RC - 14
		White / Grey

4		Front Connectors
		FSD - FC - 04

SLIM DRAWER

Cabinet Space Requirements

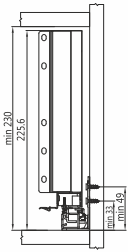

Front Connectors Panel Mounting dimension

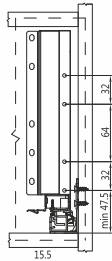

Inserta & General Panel Mounting hole size

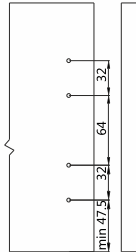

Mounting Dimensions for the back plate

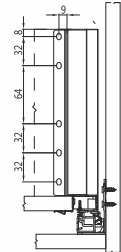

The drawer runners mounting dimensions

Nominal Length (mm)

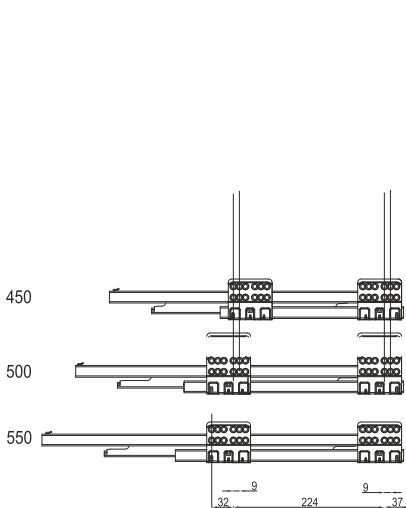

Rail mounting hole distance

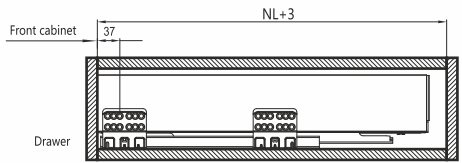

Cutting Dimensions for 16mm - thick MDF

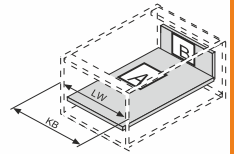
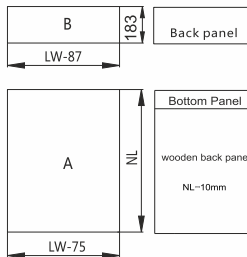

KB Cabinet width
LW Internal cabinet width
NL Normal Length

SLIM DRAWER

Slim Wall Double Wall Drawer Slide With Inner Front Panel Height 84mm

FISD - 84 - 05 Loading Capacity 40 kgs



Luxury, Silence, Smooth, Soft closing, Full extension. New safety device to prevent drawer fall out. Heavy- duty, useful life more than 80,000 times. Easy to take drawer out and put it on. Easy for consumer to clear the drawer. Various sizes and components available to meet different consumer's requirement. Up & down 4mm adjustable, left & right 3mm adjustable. Length: 350 / 400 / 450 / 500 / 550 mm.

Product Information

Space Required

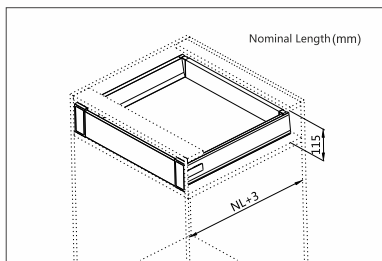

Components View

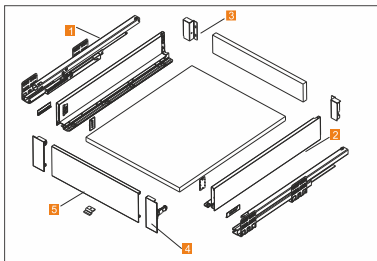

1		Drawer slide L/R
		Loading Capacity 40 Kg
FSD - 84		350 / 400 / 450 / 500 / 550 mm

2		Decorative Covers L/R
		FSD - 84-02
		350 / 400 / 450 / 500 / 550 mm
	Colour	White / Grey

3		Rear Connectors L/R
		FSD - RC - 11
		White / Grey

4		Inner Drawer Front Connectors L/R
		FISD - FC- 84P
		White / Grey

SLIM DRAWER

5		Inner Front Panel
FISD - FP - 01		900 / 1200 mm
Colour		White / Grey

Cabinet Space Requirements

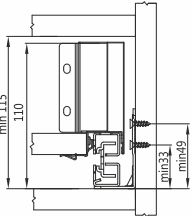

Front Connectors Panel Mounting dimension

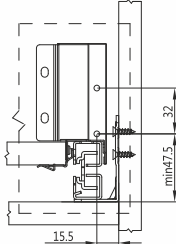

Inserts & General Panel Mounting hole size

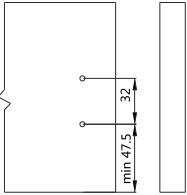

Mounting Dimensions for the back plate

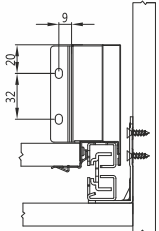

The drawer runners mounting dimensions

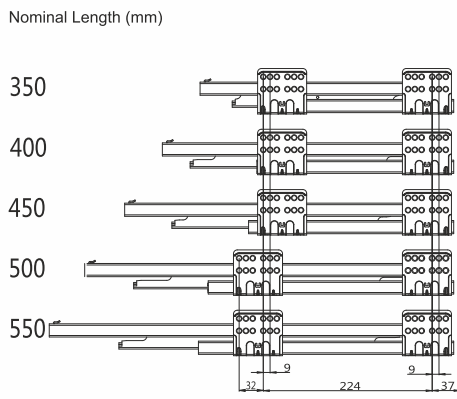

Rail mounting hole distance

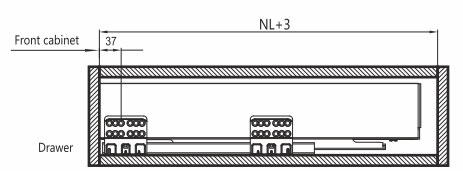

Cutting Dimensions for 16mm - thick MDF

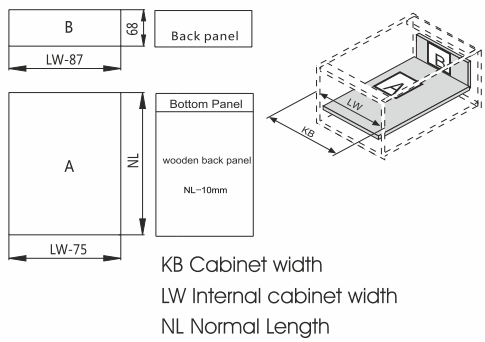

SLIM DRAWER

Slim Wall Double Wall Drawer Slide With Inner Front Panel & Square bar Height 167mm

FISD - 167 - 06 Loading Capacity 40 kgs



Luxury, Silence, Smooth, Soft closing, Full extension. New safety device to prevent drawer fall out. Heavy- duty, useful life more than 80,000 times. Easy to take drawer out and put it on. Easy for consumer to clear the drawer.

Various sizes and components available to meet different consumer's requirement.

Up & down 4mm adjustable, left & right 3mm adjustable.

Length: 350 / 400 / 450 / 500 / 550 mm.

Product Information

Space Required

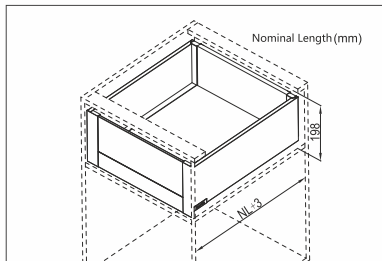

Components View

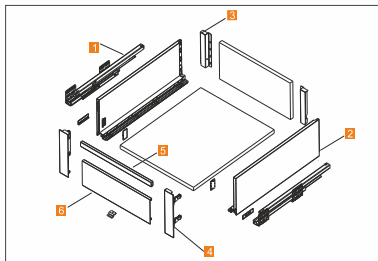

1		Drawer slide L/R
		Loading Capacity 40 Kg
FSD - 167		350 / 400 / 450 / 500 / 550 mm

2		Decorative Covers L/R
		FSD - 167-04
	Colour	White / Grey

3		Rear Connectors L/R
		FSD - RC - 13
	White / Grey	

4		Inner Drawer Front Connectors L/R
		FSD - FC - 167RP
	White / Grey	

SLIM DRAWER

Slim Wall Double Wall Drawer Slide With Inner Front Panel & Half Glass Height 167mm

FISD - 167 - 07 Loading Capacity 40 kgs



Luxury, Silence, Smooth, Soft closing, Full extension. New safety device to prevent drawer fall out. Heavy-duty, useful life more than 80,000 times. Easy to take drawer out and put it on. Easy for consumer to clear the drawer.

Various sizes and components available to meet different consumer's requirement.

Up & down 4mm adjustable, left & right 3mm adjustable.

Length: 350 / 00 / 450 / 500 / 550 mm.

Product Information

Space Required

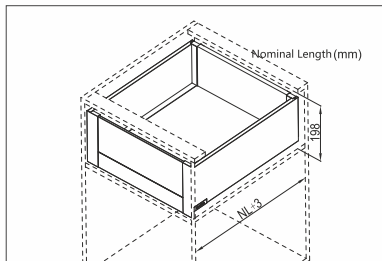

Components View

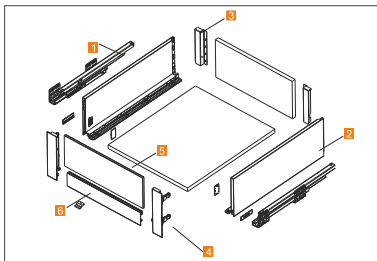

1		Drawer slide L/R
		Loading Capacity 40 Kg
FSD - 167		350 / 400 / 450 / 500 / 550 mm

2		Decorative Covers L/R
		FSD - 167-04
		350 / 400 / 450 / 500 / 550 mm
	Colour	White / Grey

3		Rear Connectors L/R
		FSD - RC - 13
		White / Grey

4		Inner Drawer Front Connectors L/R
		FISD - FC - 167 - HGP
		White / Grey

SLIM DRAWER

5		Inner Front Half Glass
FISD - 167 HG	600 / 900 / 1200 mm	
Colour	Transparent / Frosted	

6		Inner Front Panel
FISD - FP - 02	900 / 1200 mm	
Colour	White / Grey	

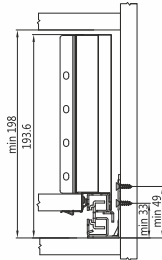
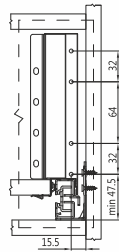
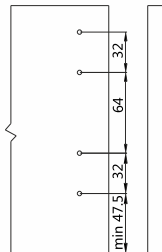
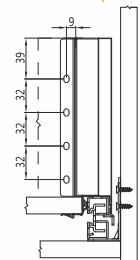
<p>Cabinet Space Requirements</p> 	<p>Front Connectors Panel Mounting dimension</p> 	<p>Inserta & General Panel Mounting hole size</p> 	<p>Mounting Dimensions for the back plate</p> 
--	---	--	--

The drawer runners mounting dimensions

Rail mounting hole distance

Nominal Length (mm)

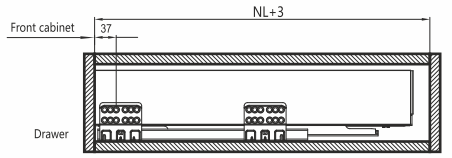
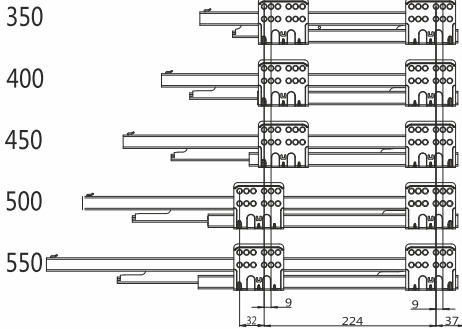

Cutting Dimensions for 16mm - thick MDF

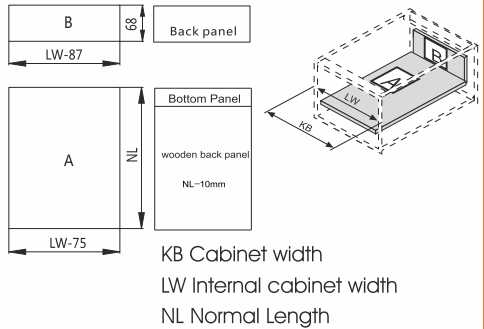

SLIM DRAWER

Slim Wall Double Wall Drawer Slide With Inner Front Panel & Full Glass Height 167mm

FISD - 167 - 08 Loading Capacity 40 kgs



Luxury, Silence, Smooth, Soft closing, Full extension. New safety device to prevent drawer fall out. Heavy-duty, useful life more than 80,000 times. Easy to take drawer out and put it on. Easy for consumer to clear the drawer.

Various sizes and components available to meet different consumer's requirement.

Up & down 4mm adjustable, left & right 3mm adjustable.

Length: 350 / 400 / 450 / 500 / 550 mm.

Product Information

Space Required

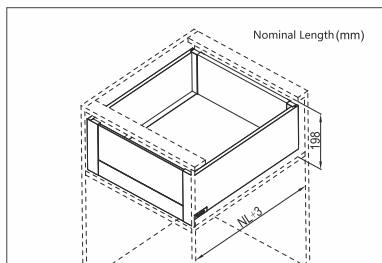

Components View

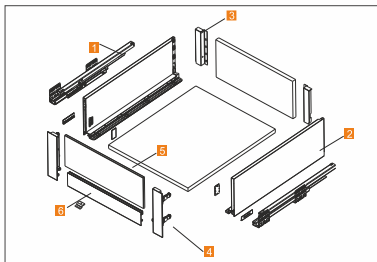

1		Drawer slide L/R
		Loading Capacity 40 Kg
FSD - 167		350 / 400 / 450 / 500 / 550 mm

2		Decorative Covers L/R
		FSD - 167-04
		350 / 400 / 450 / 500 / 550 mm
	Colour	White / Grey

3		Rear Connectors L/R
		FSD - RC - 13
		White / Grey

4		Inner Drawer Front Connectors L/R
		FISD-FC-167-FGP
		White / Grey

SLIM DRAWER

5		Inner Front Full Glass
FISD - 167 FG	600 / 900 / 1200 mm	
Colour	Transparent / Frosted	

6		Inner Front Panel
FISD - FP - 02	900 / 1200 mm	
Colour	White / Grey	

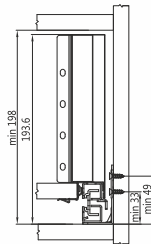
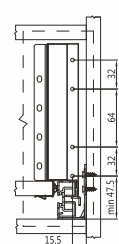
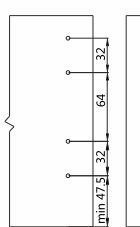
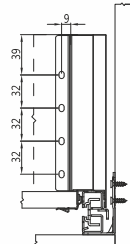
<p>Cabinet Space Requirements</p> 	<p>Front Connectors Panel Mounting dimension</p> 	<p>Inserta & General Panel Mounting hole size</p> 	<p>Mounting Dimensions for the back plate</p> 
--	---	--	--

The drawer runners mounting dimensions

Rail mounting hole distance

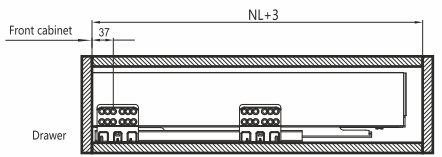
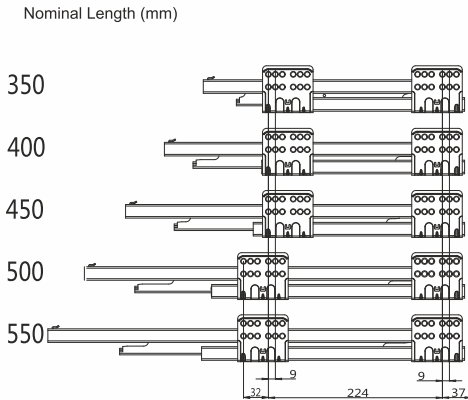

Cutting Dimensions for 16mm - thick MDF

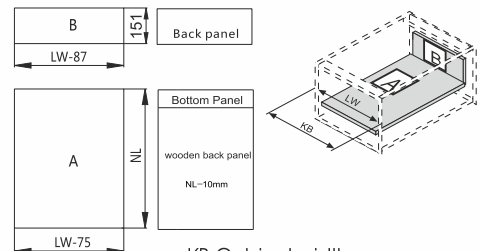

KB Cabinet width
LW Internal cabinet width
NL Normal Length

SLIM DRAWER

Slim Wall Double Wall Drawer Slide With Inner Front Panel & Square bar Height 199mm

FISD - 199 - 09 Loading Capacity 40 kgs



Luxury, Silence, Smooth, Soft closing, Full extension. New safety device to prevent drawer fall out. Heavy-duty, useful life more than 80,000 times. Easy to take drawer out and put it on. Easy for consumer to clear the drawer.

Various sizes and components available to meet different consumer's requirement.

Up & down 4mm adjustable, left & right 3mm adjustable.

Length: 450 / 500 / 550 mm.

Product Information

Space Required

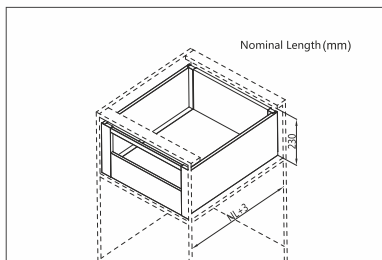

Components View

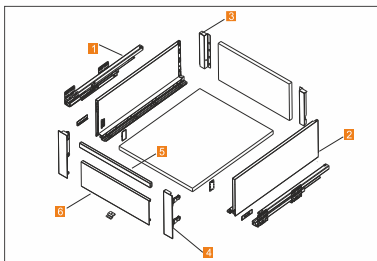

1		Drawer slide L/R
		Loading Capacity 40 Kg
FSD - 199		450 / 500 / 550 mm

2		Decorative Covers L/R
		FSD - 199-05
		450 / 500 / 550 mm
	Colour	White / Grey

3		Rear Connectors L/R
		FSD - RC - 14
		White / Grey

4		Inner Drawer Front Connectors L/R
		FISD-FC-199 RP
		White / Grey

SLIM DRAWER

Slim Wall Double Wall Drawer Slide With Inner Front Panel & Half Glass Height 199mm

FSD - 199 - 10 Loading Capacity 40 kgs



Luxury, Silence, Smooth, Soft closing, Full extension. New safety device to prevent drawer fall out. Heavy-duty, useful life more than 80,000 times. Easy to take drawer out and put it on. Easy for consumer to clear the drawer.

Various sizes and components available to meet different consumer's requirement.

Up & down 4mm adjustable, left & right 3mm adjustable.

Length: 450/ 500 / 550 mm.

Product Information

Space Required

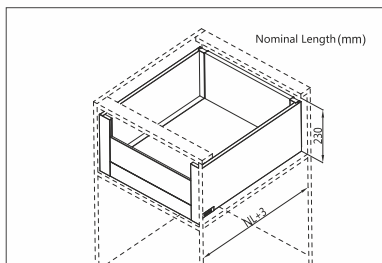

Components View

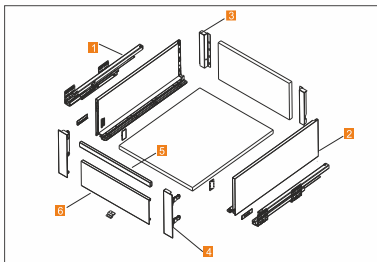

1		Drawer slide L/R
		Loading Capacity 40 Kg
FSD - 199		450 / 500 / 550 mm

2		Decorative Covers L/R
		FSD - 199-05
	Colour	White / Grey

3		Rear Connectors L/R
		FSD - RC - 14

4		Inner Drawer Front Connectors L/R
		FISD-FC-199 HGP

SLIM DRAWER

5		Inner Front Half Glass
FISD - 199 HG	600 / 900 / 1200 mm	
Colour	Transparent / Frosted	

6		Inner front Panel
FISD - FP - 02	900 / 1200 mm	
Colour	White / Grey	

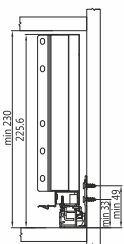
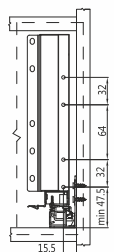
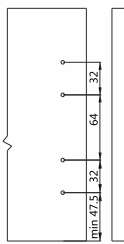
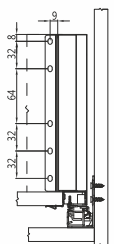
<p>Cabinet Space Requirements</p> 	<p>Front Connectors Panel Mounting dimension</p> 	<p>Inserta & General Panel Mounting hole size</p> 	<p>Mounting Dimensions for the back plate</p> 
--	---	--	--

The drawer runners mounting dimensions

Nominal Length (mm)

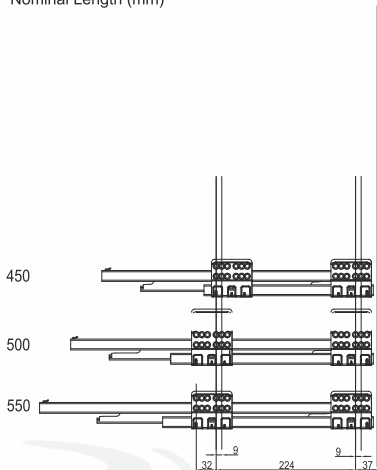

Rail mounting hole distance

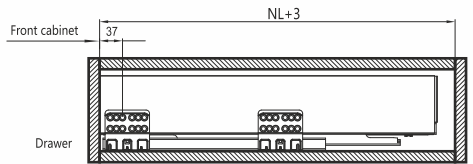

Cutting Dimensions for 16mm - thick MDF

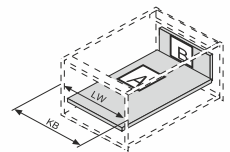
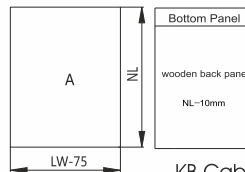
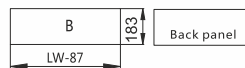

KB Cabinet width
LW Internal cabinet width
NL Normal Length

SLIM DRAWER

Slim Wall Double Wall Drawer Slide With Inner Front Panel & Full Glass Height 199mm

FISD - 199 - 11 Loading Capacity 40 kgs



Luxury, Silence, Smooth, Soft closing, Full extension. New safety device to prevent drawer fall out. Heavy-duty, useful life more than 80,000 times. Easy to take drawer out and put it on. Easy for consumer to clear the drawer.

Various sizes and components available to meet different consumer's requirement.

Up & down 4mm adjustable, left & right 3mm adjustable.

Length: 450 / 500 / 550 mm.

Product Information

Space Required

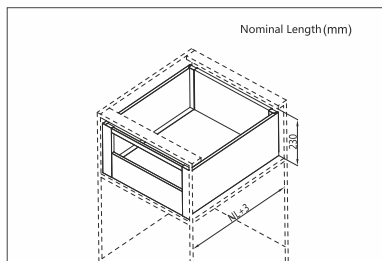

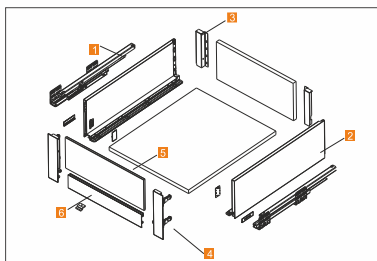

Components View



1		Drawer slide L/R	FSD - 199	450 / 500 / 550 mm
		Loading Capacity 40 Kg		
2		Decorative Covers L/R	FSD - 199-05	450 / 500 / 550 mm
		Colour	White / Grey	
3		Rear Connectors L/R	FSD - RC - 14	White / Grey
4		Inner Drawer Front Connectors L/R	FISD-FC-199-FGP	White / Grey

SLIM DRAWER

5		Inner Front Full Glass
FISD - 199 FG	600 / 900 / 1200 mm	
Colour	Transparent / Frosted	

6		Inner Front Panel
FISD - FP - 02	900 / 1200 mm	
Colour	White / Grey	

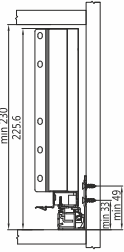
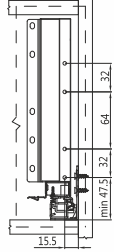
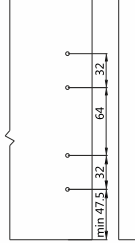
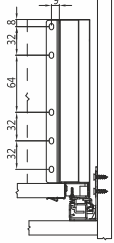
<p>Cabinet Space Requirements</p> 	<p>Front Connectors Panel Mounting dimension</p> 	<p>Inserta & General Panel Mounting hole size</p> 	<p>Mounting Dimensions for the back plate</p> 
--	---	--	--

The drawer runners mounting dimensions

Rail mounting hole distance

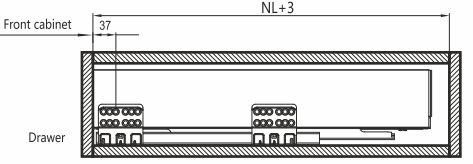
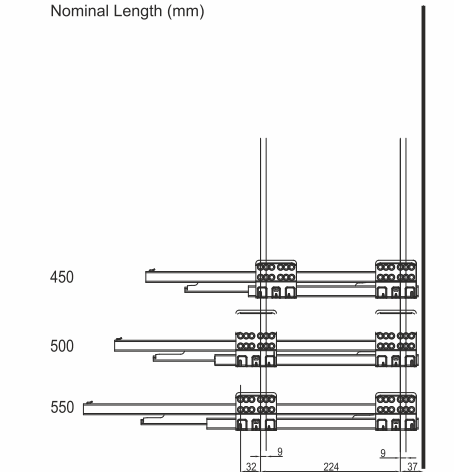

Cutting Dimensions for 16mm - thick MDF

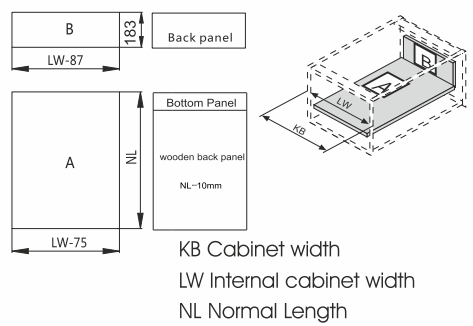

→ BASIC COMPONENTS

→ INSTALL, DISASSEMBLY AND REGULATION

Slim Drawer Height 84 mm

Install the Panel

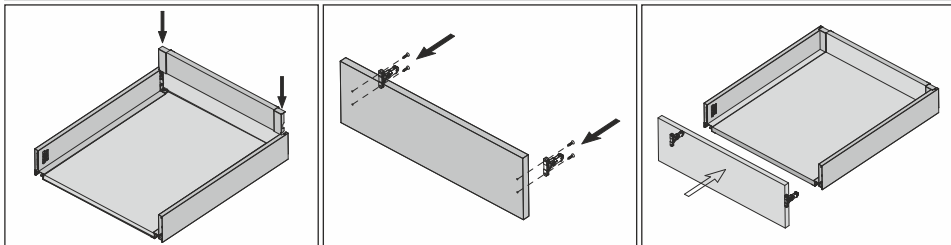

Install the drawer

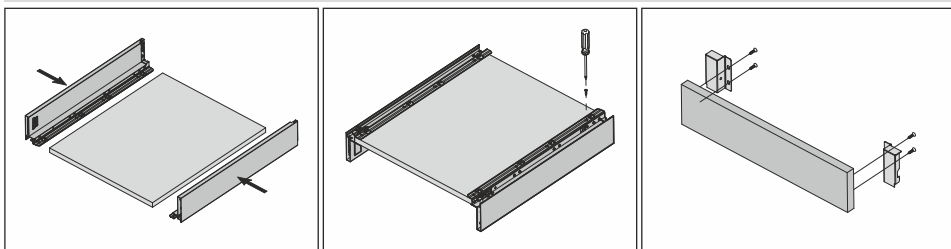

Adjustment

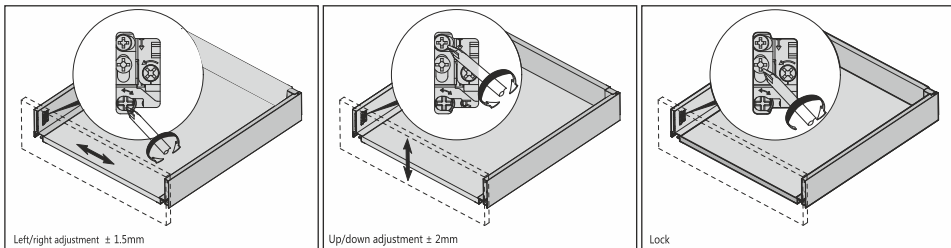

Lock and remove the panel

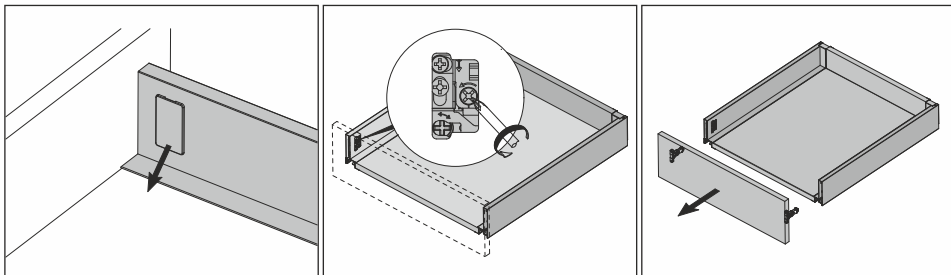

SLIM DRAWER

→ BASIC COMPONENTS

→ INSTALL, DISASSEMBLY AND REGULATION

Install and remove the drawer

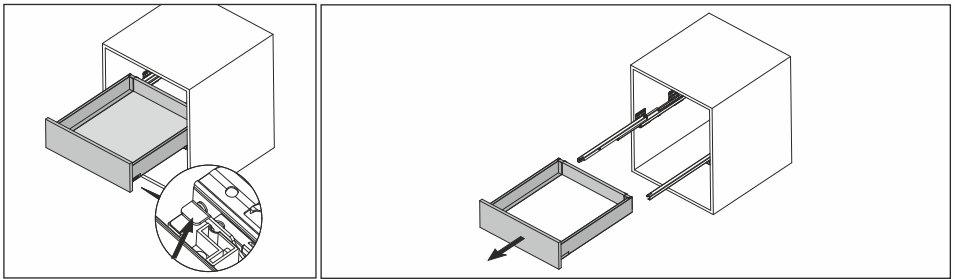
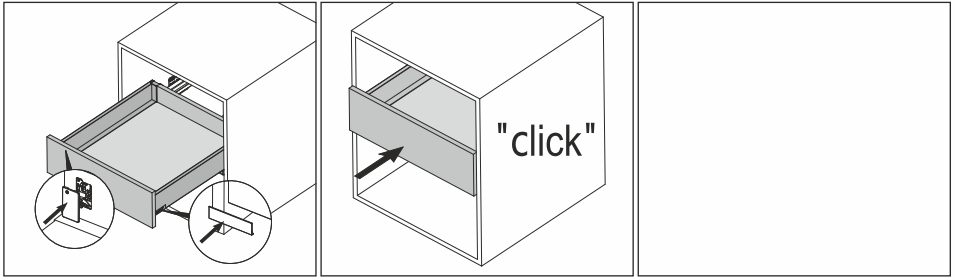

Slim inner Drawer Height 84 mm

Install the internal front panel

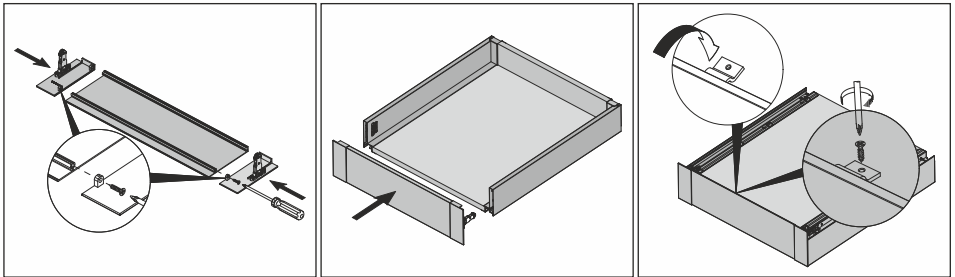

Slim inner Drawer Height 116 mm

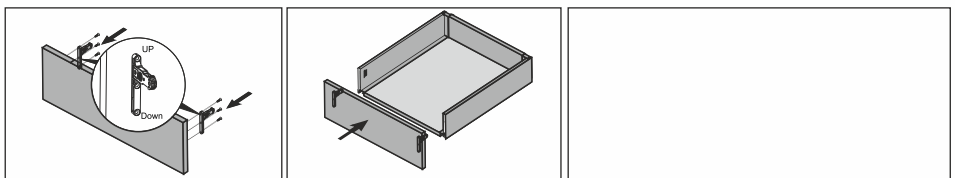

→ BASIC COMPONENTS

→ INSTALL, DISASSEMBLY AND REGULATION

Slim Drawer Height 167 & 199 mm

Install the Panel

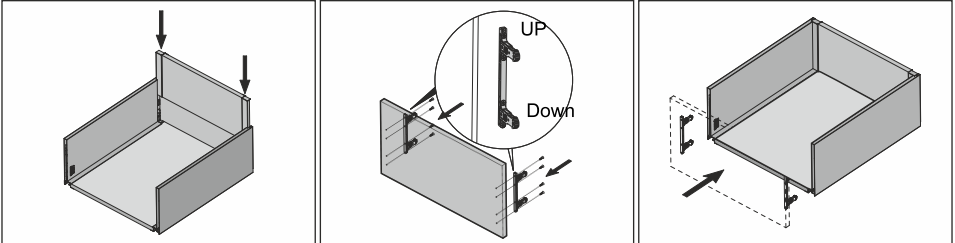

Install the drawer

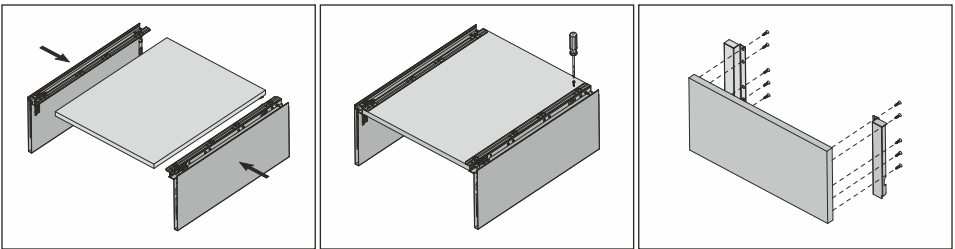

Adjustment

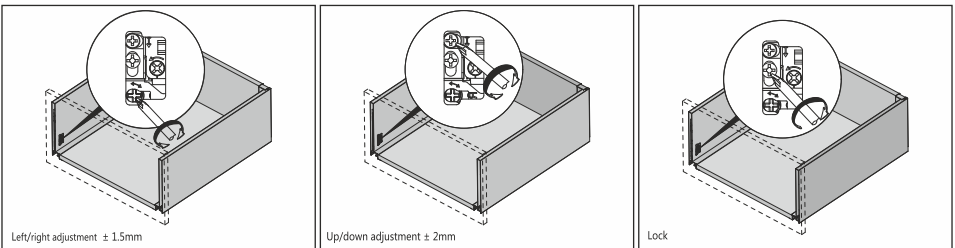

Lock and remove the panel

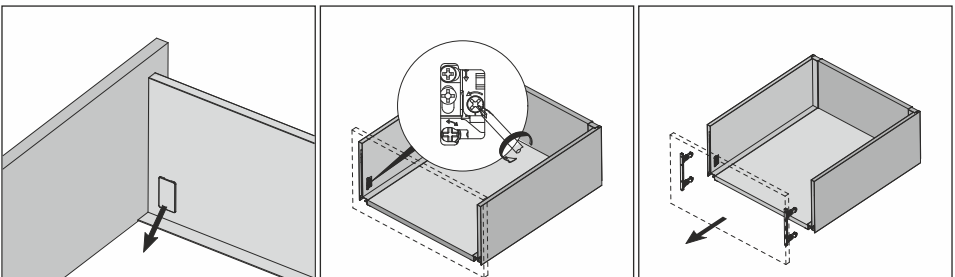

SLIM DRAWER

→ BASIC COMPONENTS

→ INSTALL, DISASSEMBLY AND REGULATION

Install and remove the drawer

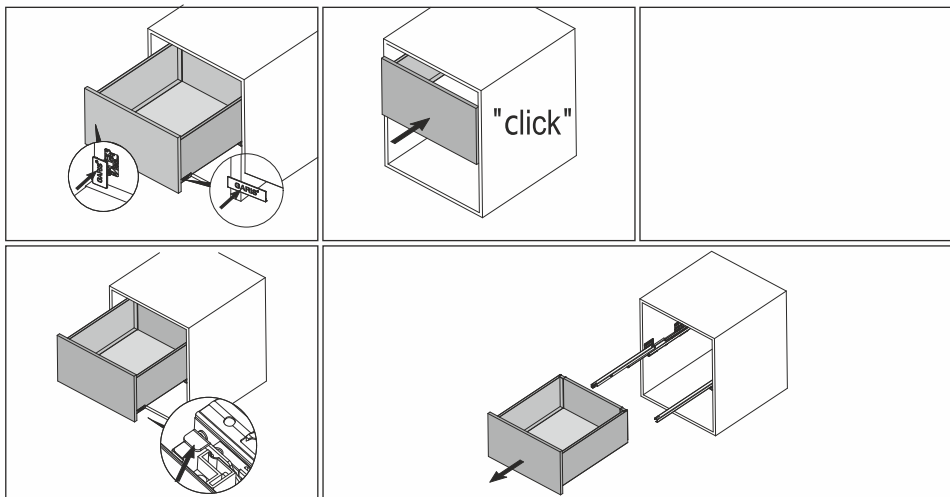

Slim inner Drawer Height 167 & 199 mm

Install the inner front panel with bar

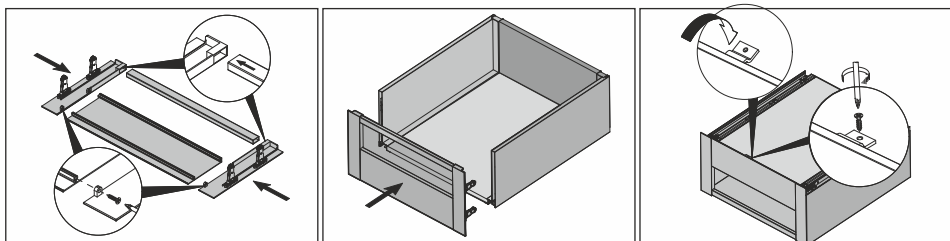

Install te inner front panel with Glass

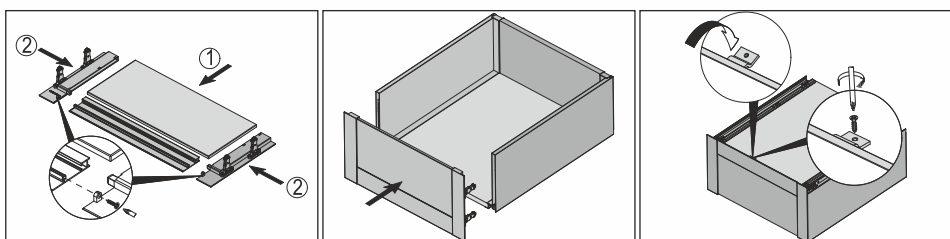

TANDEM DRAWER

Tandem Double Wall Drawer Slide Height 84mm

FTB - 84 - 12 Loading Capacity 40 kgs



Luxury, Silence, Smooth, Soft closing, Full extension. New safety device to prevent drawer fall out. Heavy-duty, useful life more than 80,000 times. Easy to take drawer out and put it on. Easy for consumer to clear the drawer.

Various sizes and components available to meet different consumer's requirement.

Up & down 4mm adjustable, left & right 3mm adjustable.

Length: 350 / 400 / 450 / 500 / 550mm.



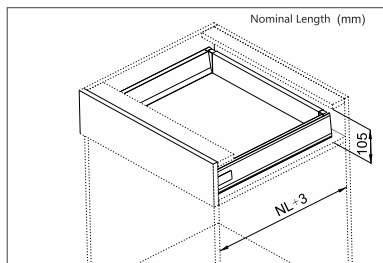

Product Information

Space Required

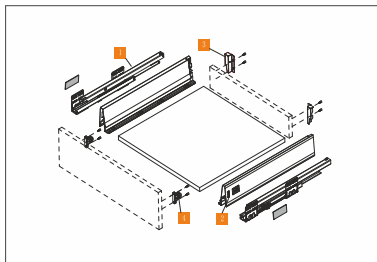

Component View



1		Cabinet Rail L/R	2		Decorative Covers L/R
		Loading Capacity 40 Kg			FTB - 84 - 01
	FTB - 84	350 / 400 / 450 / 500 / 550 mm	Colour		White / Grey
3		Rear Connectors L/R	4		Front Connectors
		FTB - RC - 15			White / Grey

TANDEM DRAWER

Cabinet Space Requirements

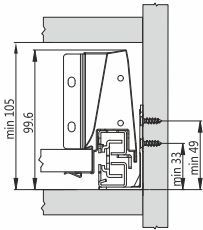

Front Connectors
Panel Mounting dimension

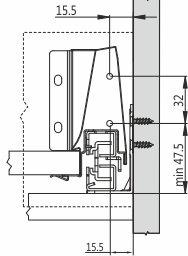

Inserts & General
Panel Mounting hole size

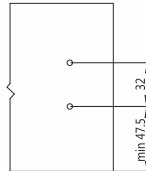

Mounting Dimensions
for the back plate

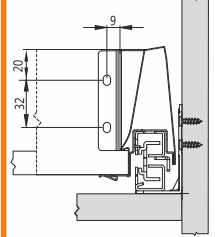

The cabinet body rail mounting dimensions

Nominal Length (mm)

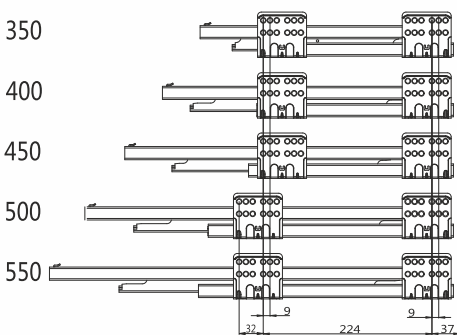

Rail mounting hole distance

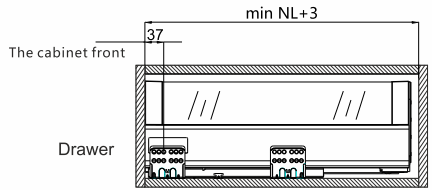

Cutting Dimensions for 16mm - thick MDF

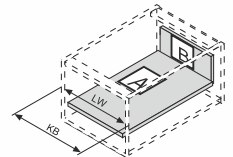
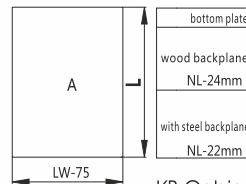
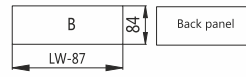

KB Cabinet width

LW Internal cabinet width

NL Normal Length

TANDEM DRAWER

Tandem Double Wall Drawer Slide With extended single square side rails height 151 mm

FTB - 84 - 13 Loading Capacity 40 kgs



Luxury, Silence, Smooth, Soft closing, Full extension. New safety device to prevent drawer fall out. Heavy-duty, useful life more than 80,000 times. Easy to take drawer out and put it on. Easy for consumer to clear the drawer.

Various sizes and components available to meet different consumer's requirement.

Up & down 4mm adjustable, left & right 3mm adjustable.

Length: 350 / 400 / 450 / 500 / 550mm.



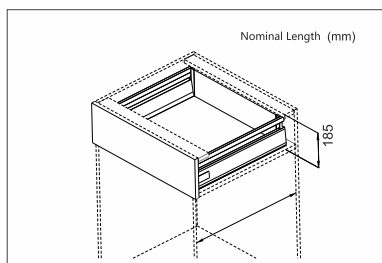

Product Information

Space Required

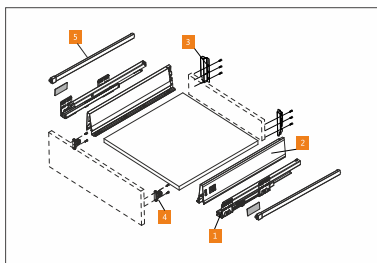

Component View



1		Cabinet Rail L/R	2		Decorative Covers L/R
	FTB - 84	350 / 400 / 450 / 500 / 550 mm		FTB - 84 - 01	350 / 400 / 450 / 500 / 550 mm
			Colour	White / Grey	
3		Rear Connectors L/R	4		Front Connectors
	FTB - RC - 16	White / Grey		FTB - FC - 05	

TANDEM DRAWER

5		Square Rail
FTB - SR	350 / 400 / 450 / 500 / 550 mm	
Colour	White / Grey	

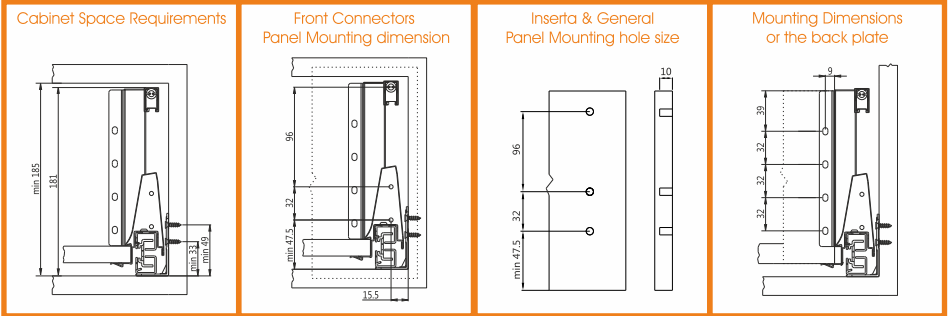

The cabinet body rail mounting dimensions

Nominal Length (mm)

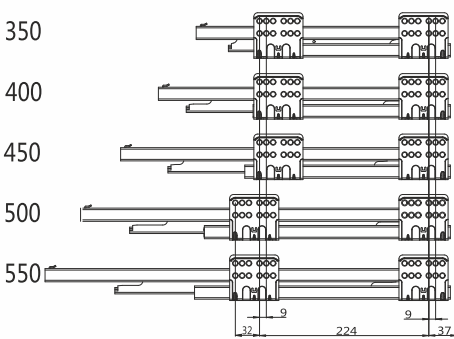

Rail mounting hole distance

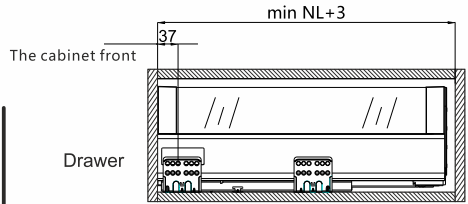

Cutting Dimensions for 16mm - thick MDF

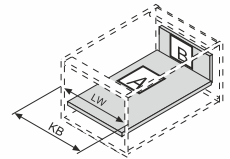
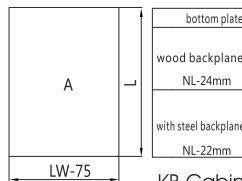
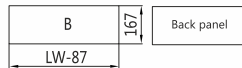

KB Cabinet width
LW Internal cabinet width
NL Normal Length

TANDEM DRAWER

Tandem Double Wall Drawer Slide With extended single square side rails height 183 mm

FTB - 84 - 14 Loading Capacity 40 kgs



Luxury, Silence, Smooth, Soft closing, Full extension. New safety device to prevent drawer fall out. Heavy-duty, useful life more than 80,000 times. Easy to take drawer out and put it on. Easy for consumer to clear the drawer.

Various sizes and components available to meet different consumer's requirement.

Up & down 4mm adjustable, left & right 3mm adjustable.

Length: 350 / 400 / 450 / 500 / 550mm.

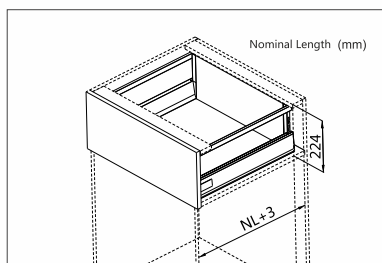

Product Information

Space Required

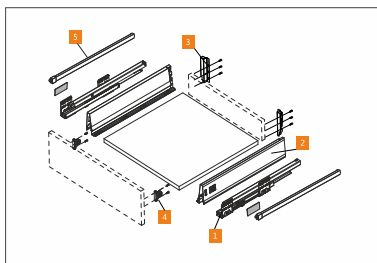

Component View



1		Cabinet Rail L/R	2		Decorative Covers L/R
	FTB - 84	350 / 400 / 450 / 500 / 550 mm		FTB - 84 - 01	350 / 400 / 450 / 500 / 550 mm
		Loading Capacity 40 Kg	Colour	White / Grey	
3		Rear Connectors L/R	4		Front Connectors
FTB - RC - 17	White / Grey		FTB - FC - 05		

TANDEM DRAWER

5		Square Rail
FTB - SR	350 / 400 / 450 / 500 / 550 mm	
Colour	White / Grey	

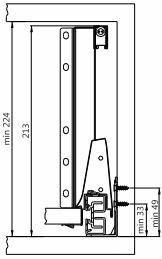
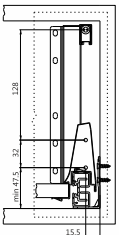
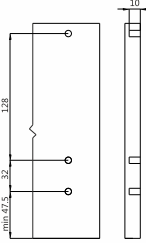
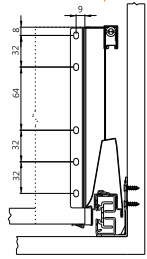
<p>Cabinet Space Requirements</p> 	<p>Front Connectors Panel Mounting dimension</p> 	<p>Inserts & General Panel Mounting hole size</p> 	<p>Mounting Dimensions for the back plate</p> 
--	---	--	--

The cabinet body rail mounting dimensions

Nominal Length (mm)

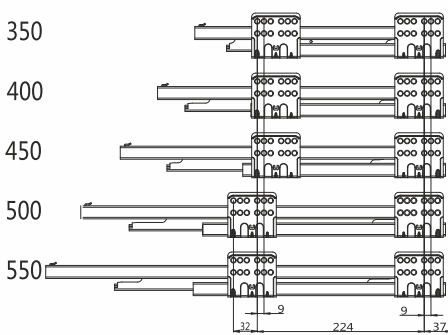

Rail mounting hole distance

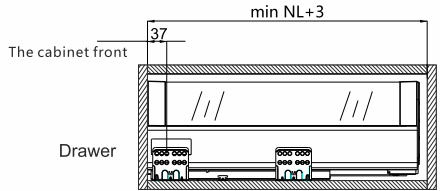

Cutting Dimensions for 16mm - thick MDF

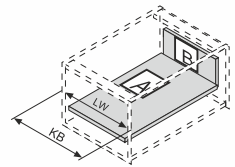
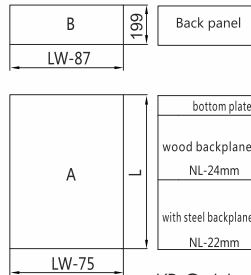

KB Cabinet width
LW Internal cabinet width
NL Normal Length

TANDEM DRAWER

Tandem Double Wall Drawer Slide With extended Double square side rails height 183 mm
FTB - 84 - 15 Loading Capacity 40 kgs



Luxury, Silence, Smooth, Soft closing, Full extension. New safety device to prevent drawer fall out. Heavy-duty, useful life more than 80,000 times. Easy to take drawer out and put it on. Easy for consumer to clear the drawer.

Various sizes and components available to meet different consumer's requirement.

Up & down 4mm adjustable, left & right 3mm adjustable.

Length: 350 / 400 / 450 / 500 / 550mm.

Product Information

Space Required

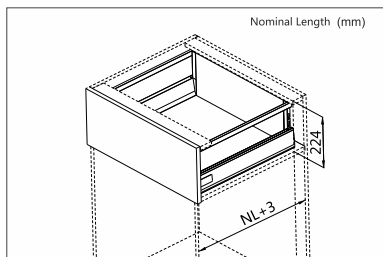

Component View

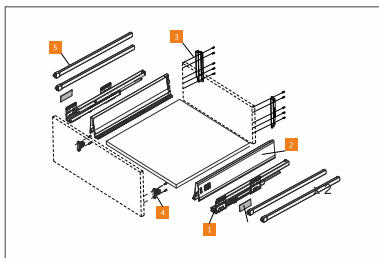

1		Cabinet Rail L/R
		Loading Capacity 40 Kg
FTB - 84		350 / 400 / 450 / 500 / 550 mm

2		Decorative Covers L/R
		FTB - 84 - 01
	Colour	White / Grey

3		Rear Connectors L/R
		FTB - RC - 17

4		Front Connectors
		FTB - FC - 05

TANDEM DRAWER

5



Square Rail x 2

FTB - SR

350 / 400 / 450 / 500 / 550 mm

Colour

White / Grey

Cabinet Space Requirements

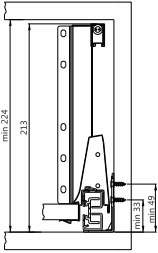

Front Connectors
Panel Mounting dimension

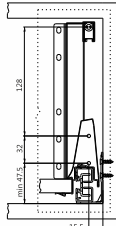

Inserts & General
Panel Mounting hole size

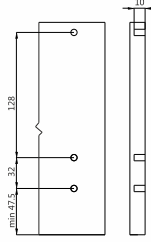

Mounting Dimensions
for the back plate

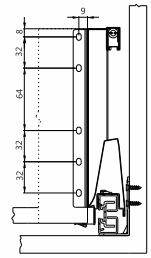

The cabinet body rail mounting dimensions

Rail mounting hole distance

Nominal Length (mm)

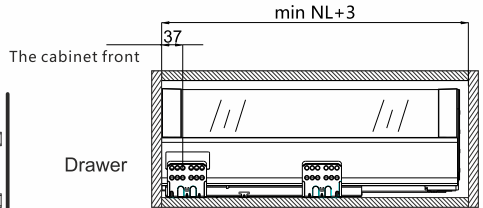
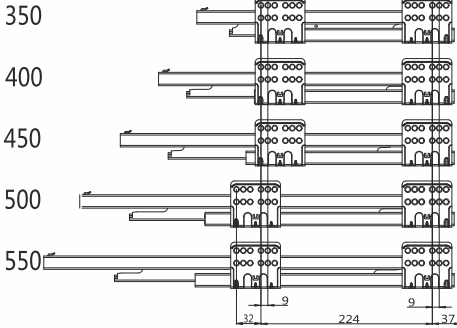

Cutting Dimensions for 16mm - thick MDF

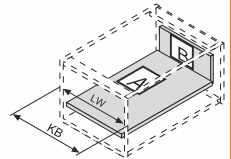
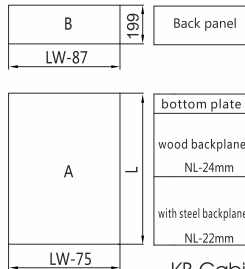

KB Cabinet width
LW Internal cabinet width
NL Normal Length

TANDEM DRAWER

Tandem Double Wall Drawer Slide With extended side Glass, height 151 mm

FTB - 84 - 16 Loading Capacity 40 kgs



Luxury, Silence, Smooth, Soft closing, Full extension. New safety device to prevent drawer fall out. Heavy-duty, useful life more than 80,000 times. Easy to take drawer out and put it on. Easy for consumer to clear the drawer.

Various sizes and components available to meet different consumer's requirement.

Up & down 4mm adjustable, left & right 3mm adjustable.

Length: 350 / 400 / 450 / 500 / 550mm.

Product Information

Space Required

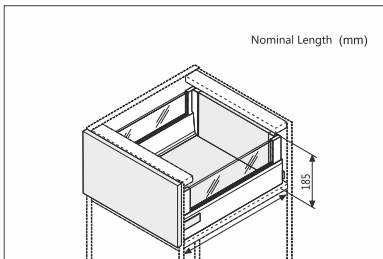

Component View

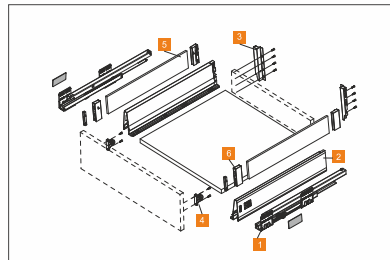

1		Cabinet Rail L/R
		Loading Capacity 40 Kg
FTB - 84		350 / 400 / 450 / 500 / 550 mm

2		Decorative Covers L/R
		FTB - 84 - 01
Colour		White / Grey

3		Rear Connectors L/R
		FTB - RC - 16

4		Front Connectors
		FTB - FC - 05

TANDEM DRAWER

5		8mm side glass
FTB - SGL - 01 T		350 / 400 / 450 / 500 / 550 mm
FTB - SGL - 01 F		350 / 400 / 450 / 500 / 550 mm
Colour		Transparent / Frosted

6		Side Glass Connector L/R
FTB - SGC - 151		White / Grey

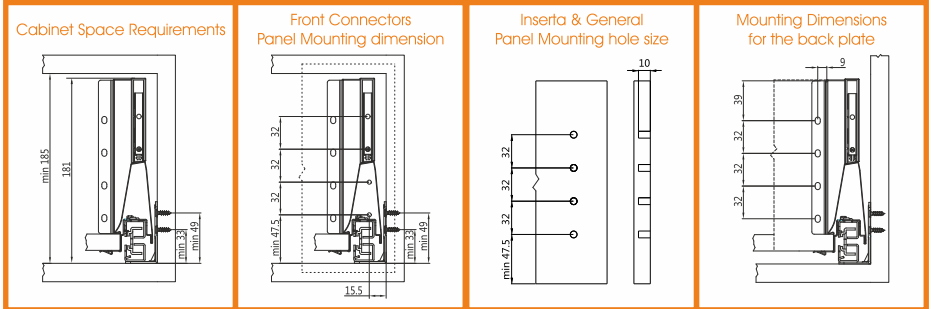

The cabinet body rail mounting dimensions

Rail mounting hole distance

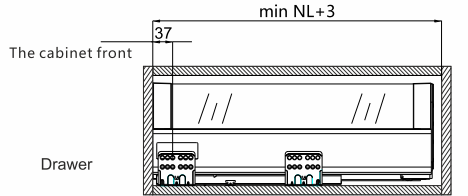
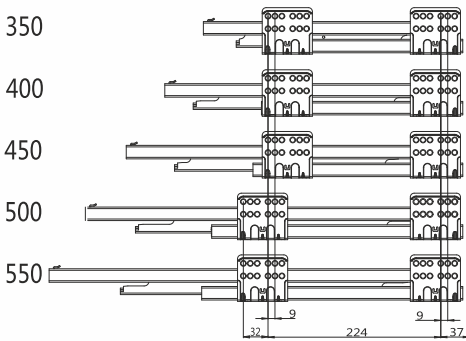

Cutting Dimensions for 16mm - thick MDF

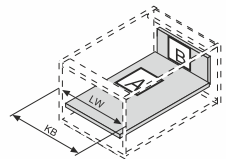
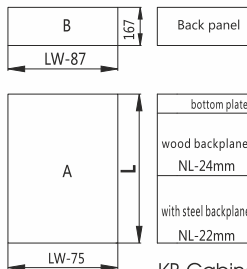

KB Cabinet width
LW Internal cabinet width
NL Normal Length

TANDEM DRAWER

Tandem Double Wall Drawer Slide With extended Side Glass, height 183 mm

FTB - 84 - 17 Loading Capacity 40 kgs



Luxury, Silence, Smooth, Soft closing, Full extension. New safety device to prevent drawer fall out. Heavy-duty, useful life more than 80,000 times. Easy to take drawer out and put it on. Easy for consumer to clear the drawer.

Various sizes and components available to meet different consumer's requirement.

Up & down 4mm adjustable, left & right 3mm adjustable.

Length: 350 / 400 / 450 / 500 / 550mm.



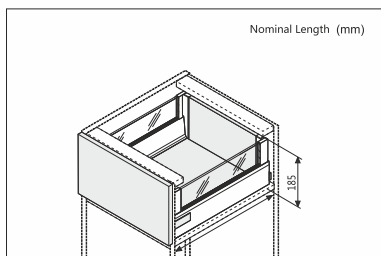

Product Information

Space Required

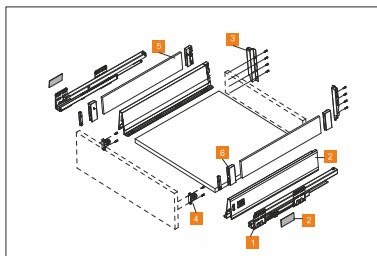

Component View



1		Cabinet Rail L/R	2		Decorative Covers L/R
		Loading Capacity 40 Kg			
	FTB - 84	350 / 400 / 450 / 500 / 550 mm		FTB - 84 - 01	350 / 400 / 450 / 500 / 550 mm
				Colour	White / Grey
3		Rear Connectors L/R	4		Front Connectors
	FTB - RC - 17	White / Grey		FTB - FC - 05	

TANDEM DRAWER

5		8mm side glass
FTB - SGL - 02 T		350 / 400 / 450 / 500 / 550 mm
FTB - SGL - 02 F		350 / 400 / 450 / 500 / 550 mm
Colour		Transparent / Frosted

6		Side Glass Connector L/R
FTB - SGC - 183		White / Grey

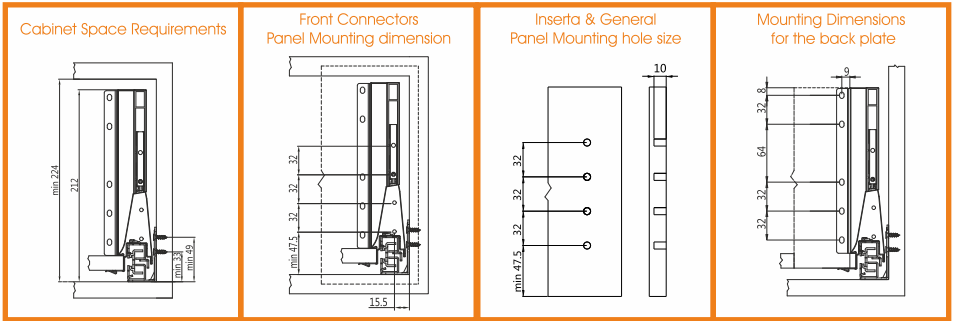

The cabinet body rail mounting dimensions

Nominal Length (mm)

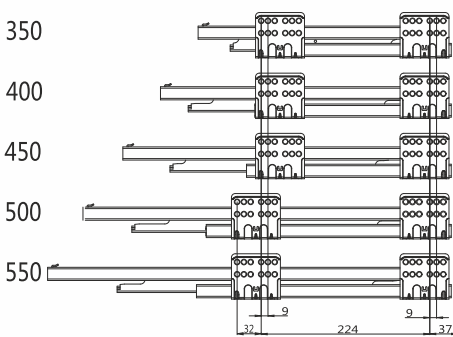

Rail mounting hole distance

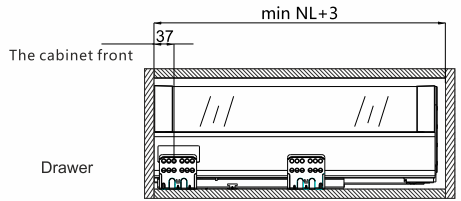

Cutting Dimensions for 16mm - thick MDF

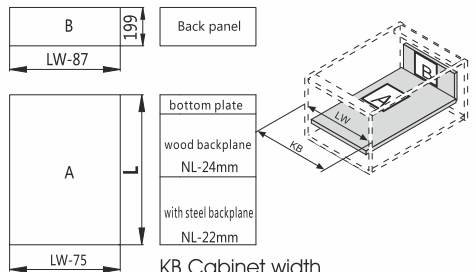

KB Cabinet width
LW Internal cabinet width
NL Normal Length

TANDEM DRAWER

Tandem Double Wall Drawer Slide With extended Inner Front Panel height 84 mm

FTB - 84 - 18 Loading Capacity 40 kgs



Luxury, Silence, Smooth, Soft closing, Full extension. New safety device to prevent drawer fall out. Heavy-duty, useful life more than 80,000 times. Easy to take drawer out and put it on. Easy for consumer to clear the drawer.

Various sizes and components available to meet different consumer's requirement.

Up & down 4mm adjustable, left & right 3mm adjustable.

Length: 350 / 400 / 450 / 500 / 550mm.

Product Information

Space Required

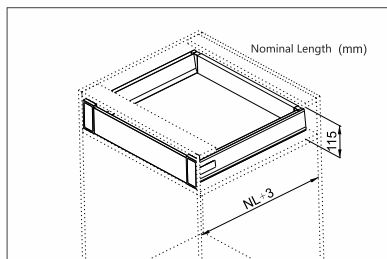

Component View

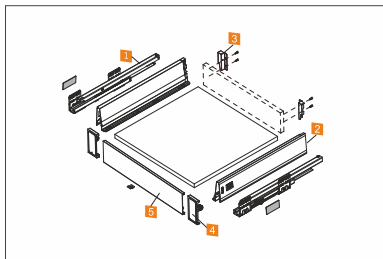

1		Cabinet Rail L/R	2		Decorative Covers L/R
		Loading Capacity 40 Kg			FTB - 84 - 01
	FTB - 84	350 / 400 / 450 / 500 / 550 mm	Colour	White / Grey	
3		Rear Connectors L/R	4		Inner Drawer Front Connector L/R
		FTB - RC - 15			White / Grey

TANDEM DRAWER

Tandem Double Wall Drawer Slide With Inner Side Glass Front Panel & Square bar With Height 151mm

FTB - 84 - 19 Loading Capacity 40 kgs



Luxury, Silence, Smooth, Soft closing, Full extension. New safety device to prevent drawer fall out. Heavy-duty, useful life more than 80,000 times. Easy to take drawer out and put it on. Easy for consumer to clear the drawer.

Various sizes and components available to meet different consumer's requirement.

Up & down 4mm adjustable, left & right 3mm adjustable.

Length: 350 / 400 / 450 / 500 / 550mm.

Product Information

Space Required

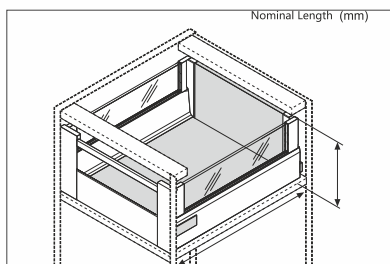

Component View

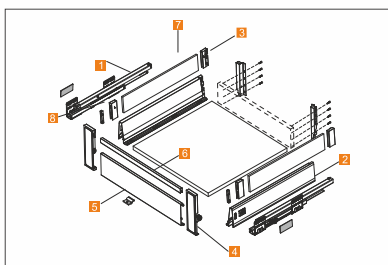

1		Cabinet Rail L/R	2		Decorative Covers L/R
		FTB - 84			350 / 400 / 450 / 500 / 550 mm
		Loading Capacity 40 Kg	Colour	White / Grey	
3		Rear Connectors L/R	4		Inner Drawer Front Connector L/R
		FTB - RC - 16			White / Grey

TANDEM DRAWER

5		Inner Front Panel
FITB - FP - 03	900 / 1200 mm	
Colour	White / Grey	

7		8mm side glass
FTB - SGL - 01 T	350 / 400 / 450 / 500 / 550 mm	
FTB - SGL - 01 F	350 / 400 / 450 / 500 / 550 mm	
Colour	Transparent / Frosted	

6		Inner Square Bar
FITB - SB - 01	900 / 1200 mm	
Colour	White / Grey	

8		Side Glass Connector
FITB - SGC - 151	White / Grey	

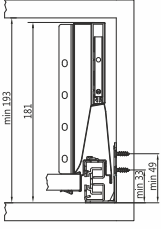
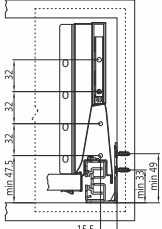
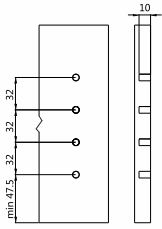
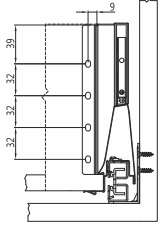
<p>Cabinet Space Requirements</p> 	<p>Front Connectors Panel Mounting dimension</p> 	<p>Inserta & General Panel Mounting hole size</p> 	<p>Mounting Dimensions for the back plate</p> 
--	---	--	--

The cabinet body rail mounting dimensions

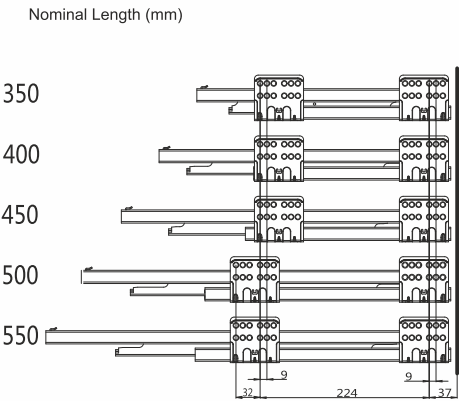

Rail mounting hole distance

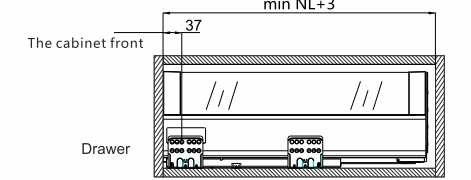

Cutting Dimensions for 16mm - thick MDF

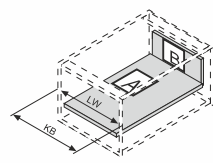
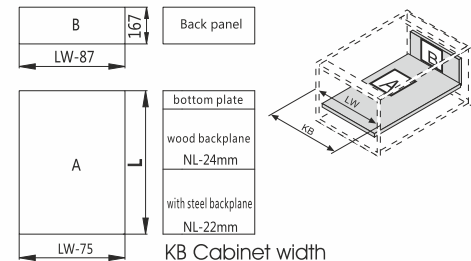

KB Cabinet width
LW Internal cabinet width
NL Normal Length

federindia.com



TANDEM DRAWER

Tandem Double Wall Drawer Slide With Inner Side Glass Front Panel
& Square bar Height 183mm

FITB - 84 - 20 Loading Capacity 40 kgs



Luxury, Silence, Smooth, Soft closing, Full extension. New safety device to prevent drawer fall out. Heavy-duty, useful life more than 80,000 times. Easy to take drawer out and put it on. Easy for consumer to clear the drawer.

Various sizes and components available to meet different consumer's requirement.

Up & down 4mm adjustable, left & right 3mm adjustable.

Length: 350 / 400 / 450 / 500 / 550mm.

Product Information

Space Required

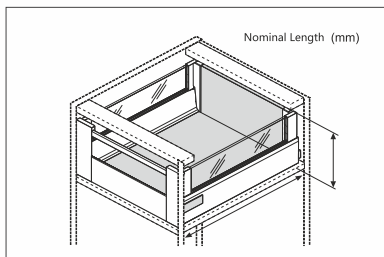

Component View

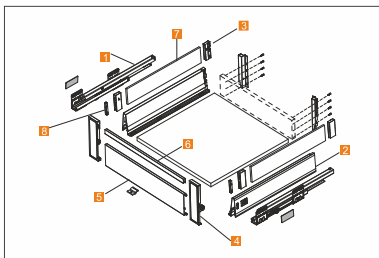

1		Cabinet Rail L/R
		Loading Capacity 40 Kg
FITB - 84		350 / 400 / 450 / 500 / 550 mm

2		Decorative Covers L/R
		FITB - 84 - 01
Colour		White / Grey

3		Rear Connectors L/R
		FITB - RC - 17

4		Inner Drawer Front Connector L/R
		FITB - FC - 183

Tandem Under Sink Drawer

FTB - 84 - 21



Product Information

Space Required

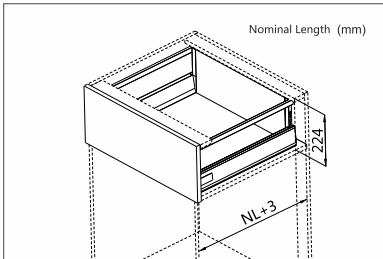

Component View

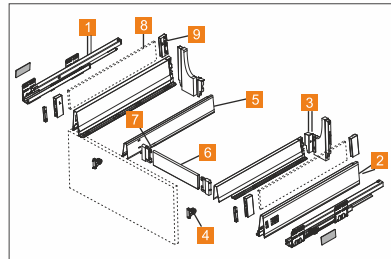

1		Cabinet Rail L/R
		Loading Capacity 40 Kg
FTB - 84		350 / 400 / 450 / 500 / 550 mm

2		Decorative Covers L/R
		FTB - 84 - 01
Colour		White / Grey

3		Rear Connectors L/R
		FTB - RC - 15
White / Grey		

4		Front Connectors
		FTB - FC - 05

TANDEM DRAWER

5		Divider side for sink Cabinet
FTB - SK - SPL	500 mm	
Colour	White / Grey	

7		Sink Divider Connector
FTB - SK - DWC	White / Grey	

9		Side Glass Connector
FITB - SGC - 151	White / Grey	

6		Sink Cabinet Divider
FTB - SK - FPL	1000 mm	
Colour	White / Grey	

8		8mm side glass
FTB - SGL - 01 T	350 / 400 / 450 / 500 / 550 mm	
FTB - SGL - 01 F	350 / 400 / 450 / 500 / 550 mm	
Colour	Transparent / Frosted	

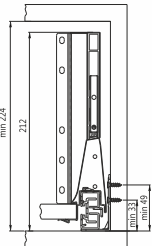
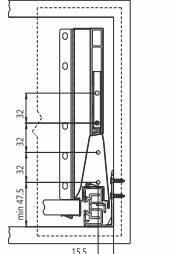
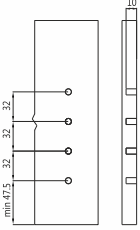
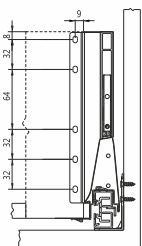
<p>Cabinet Space Requirements</p> 	<p>Front Connectors Panel Mounting dimension</p> 	<p>Inserts & General Panel Mounting hole size</p> 	<p>Mounting Dimensions for the back plate</p> 
---	--	---	---

Trimmed size 16mm drawer bottom board and backplane

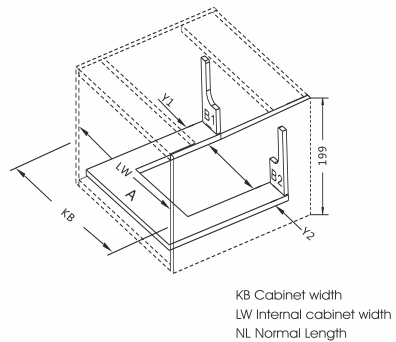
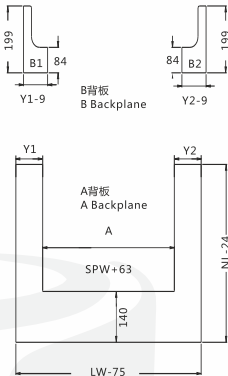

→ BASIC COMPONENTS

→ INSTALL, DISASSEMBLY AND REGULATION

Storage high cabinet with door



Ordering information

Order Recommend	Nominal Length	Packing	Recommended cabinet width
Low inner drawer	450 -500mm	1SET	Single door 450-600mm
High inner drawer	450 -500mm	4SET	Double door 800-900mm

TANDEM DRAWER

→ BASIC COMPONENTS

→ INSTALL, DISASSEMBLY AND REGULATION

Design

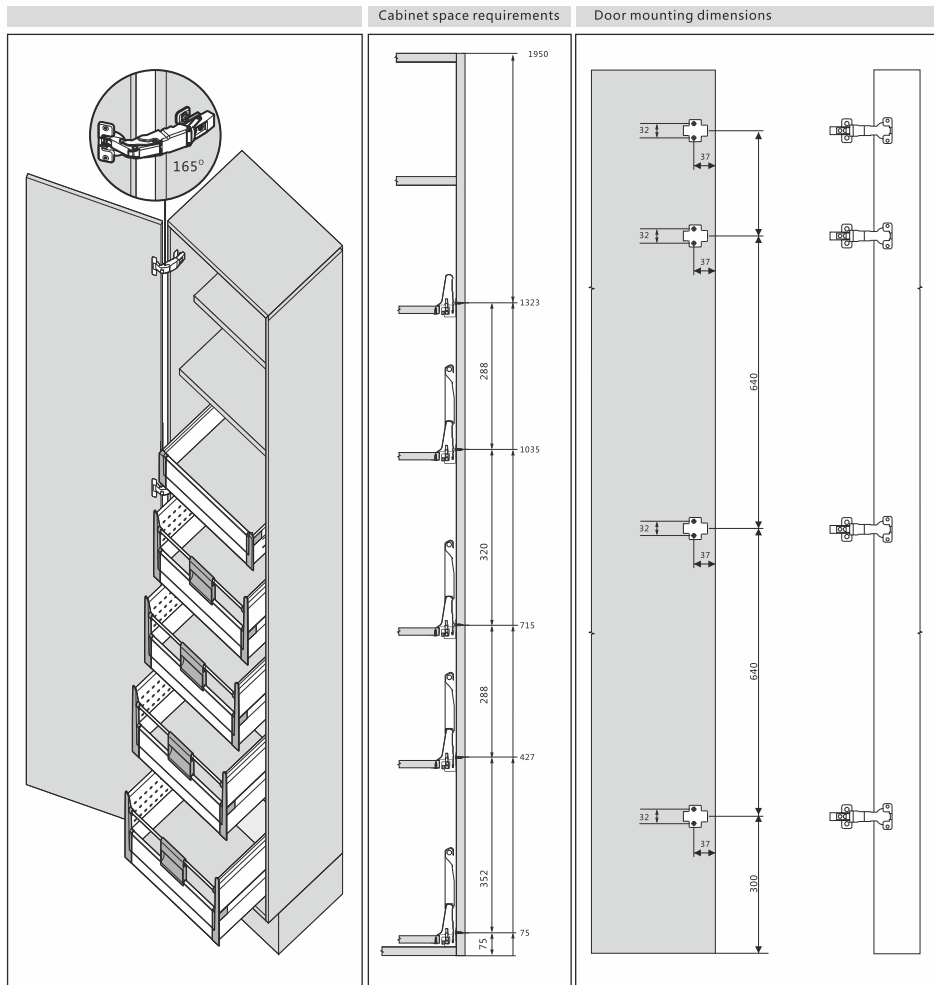

→ BASIC COMPONENTS

→ INSTALL, DISASSEMBLY AND REGULATION

Tandem Drawer

Install the Panel

Remove the Panel

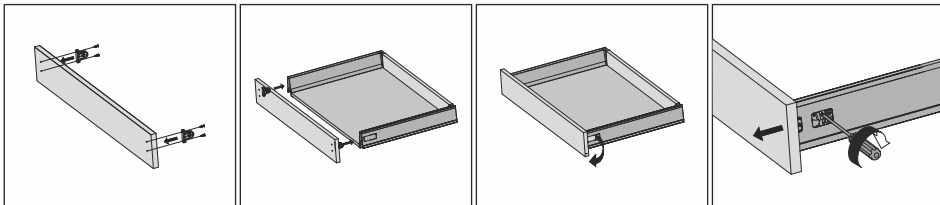

Install the drawer

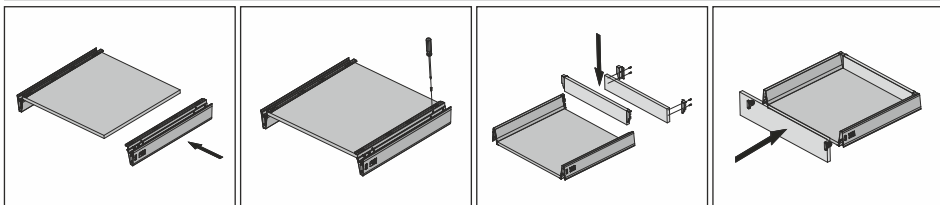

Adjustment

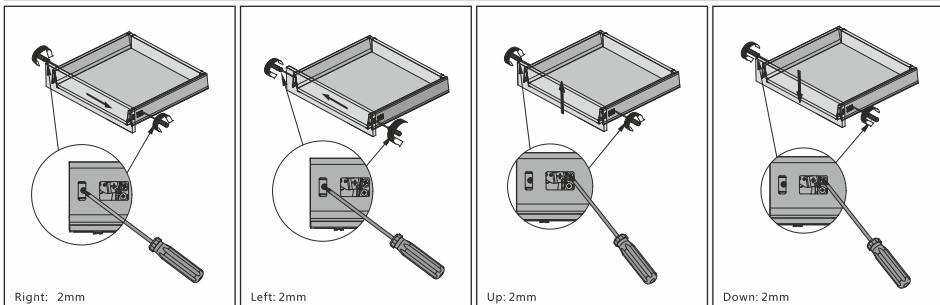

Lock and remove the panel

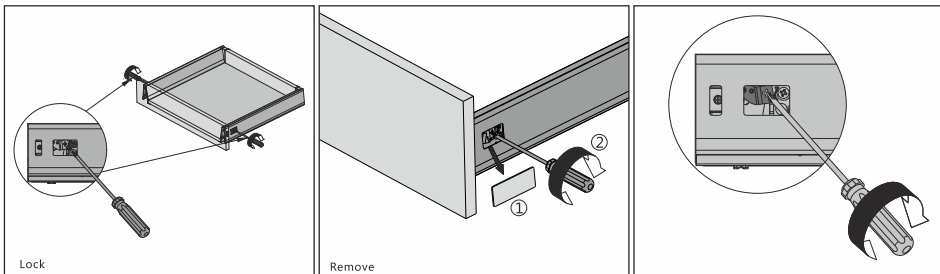

TANDEM DRAWER

→ BASIC COMPONENTS

→ INSTALL, DISASSEMBLY AND REGULATION

Install and remove the drawer

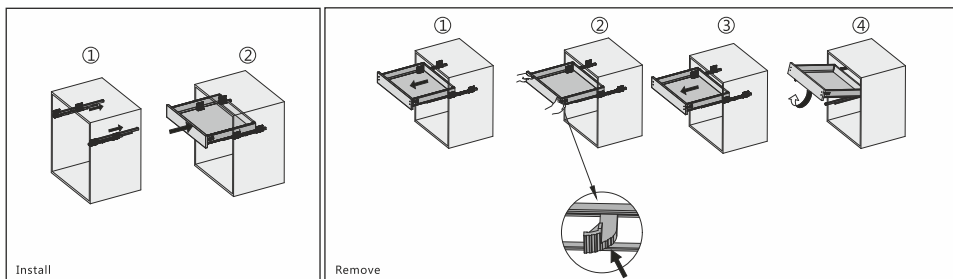

Tandem Inner Drawer

Install the front panel

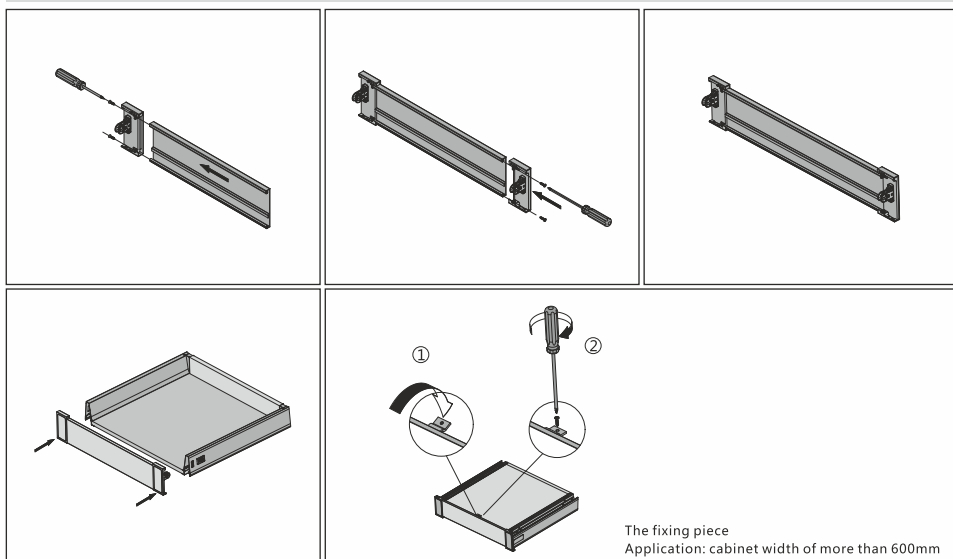

→ BASIC COMPONENTS

→ INSTALL, DISASSEMBLY AND REGULATION

Tandem High Drawer

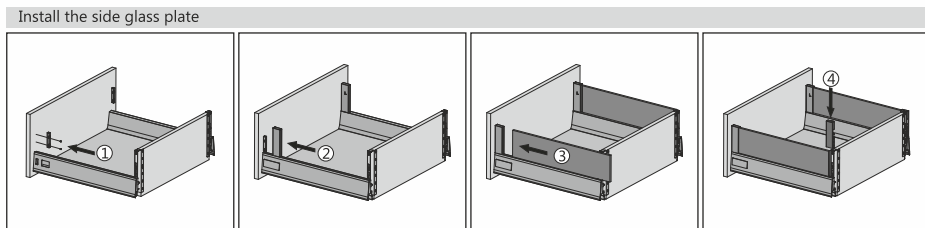
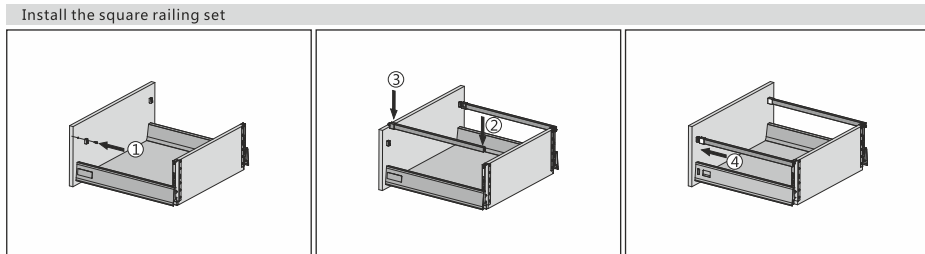
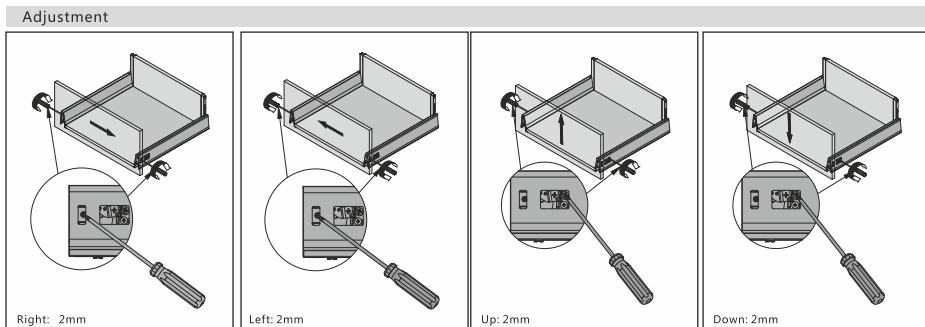
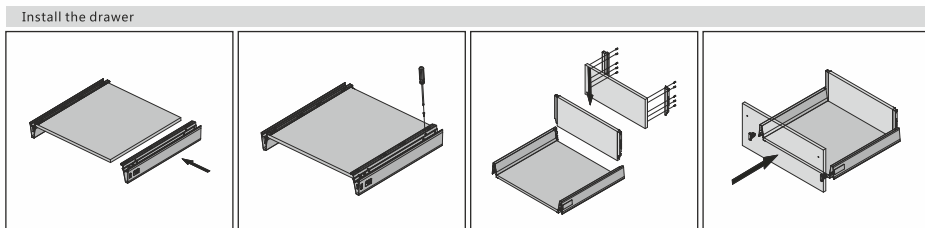
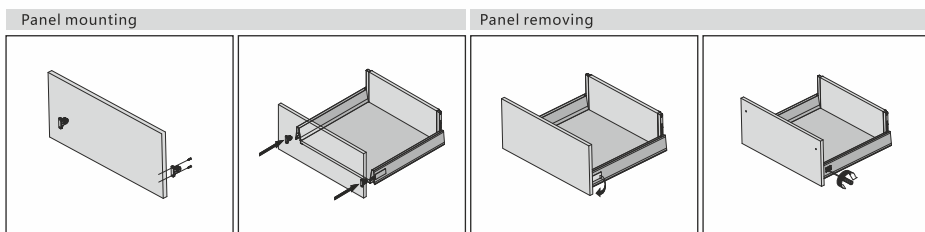

TANDEM DRAWER

→ BASIC COMPONENTS

→ INSTALL, DISASSEMBLY AND REGULATION

Tandem High Inner Drawer

Install the front panel with railing for high inner drawer

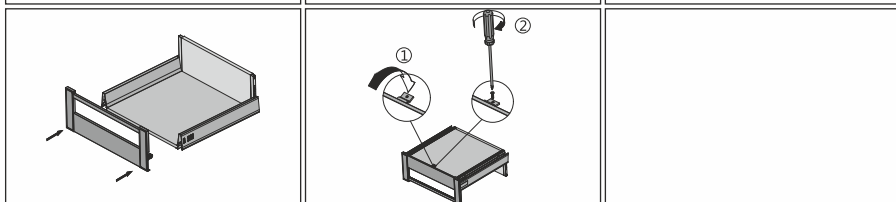
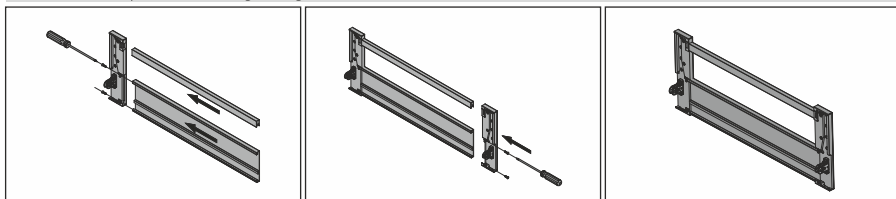

Install the front panel for high inner drawer

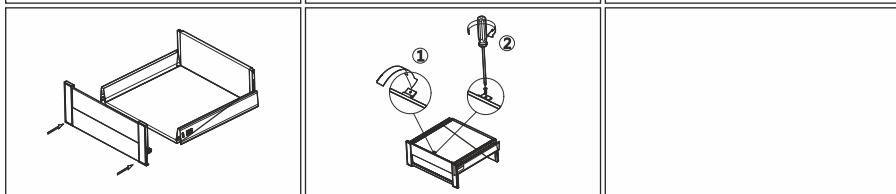
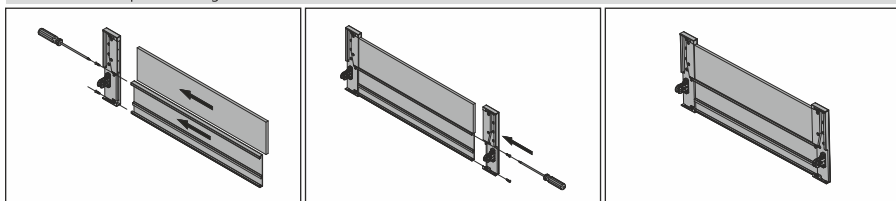

DW - Divider

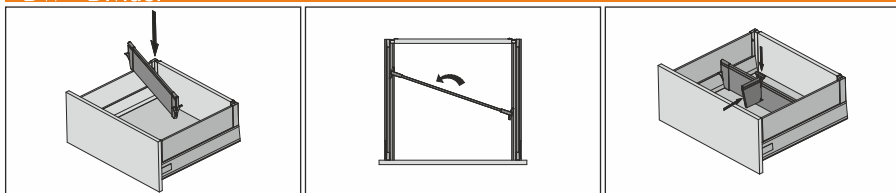

Sink Drawer

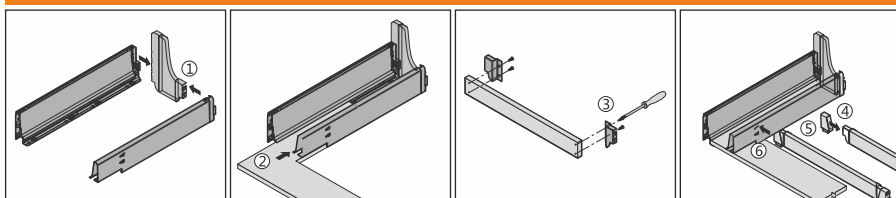

Klass Drawer Slide Height 84mm

KSD - 84 - 22 Loading Capacity 40 kgs



Luxury, Silence, Smooth, Soft closing, Full extension. New safety device to prevent drawer fall out. Heavy-duty, useful life more than 80,000 times. Easy to take drawer out and put it on. Easy for consumer to clear the drawer.

Various sizes and components available to meet different consumer's requirement.

Up & down 4mm adjustable, left & right 3mm adjustable.

Length: 450 / 500 / 550mm.

Product Information

Space Required

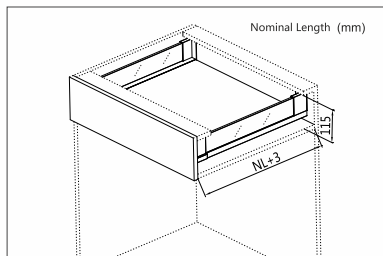

Component View

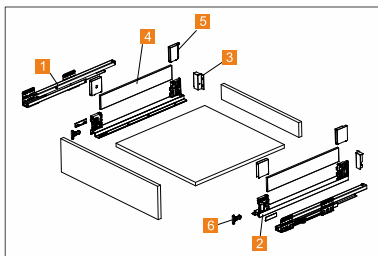

1		Cabinet Rail L/R
		Loading Capacity 40 Kg
KSD - 84		450 / 500 / 550 mm

2		Decorative Covers L/R
		KSD - 84 - 06
Colour		White / Grey

3		Rear Connectors L/R
		FSD - RC - 11

4		Glass Side Plates L / R	
		KSD - SG - 03 T	450 / 500 / 550 mm
		KSD - SG - 03 F	450 / 500 / 550 mm
Colour			Transparent / Frosted

KLASS DRAWER

5		Glass fasteners L/R
KSD - SGC - 84		White / Grey

6		Front Connectors
FSD - FC - 01		

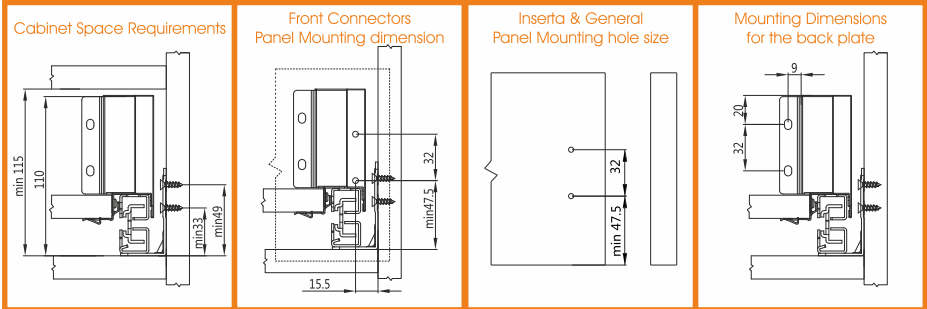

The cabinet body rail mounting dimensions

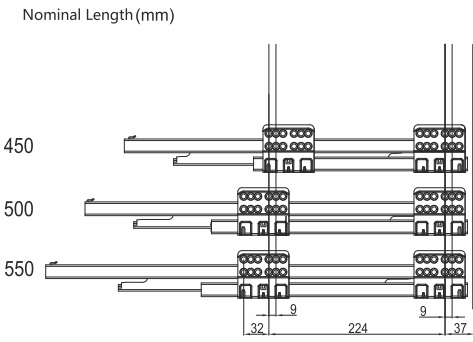

Rail mounting hole distance

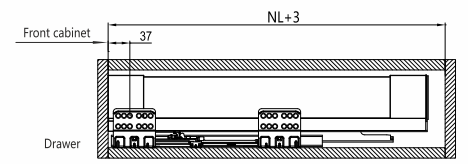

Cutting Dimensions for 16mm - thick MDF

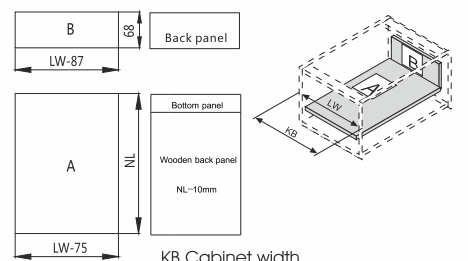

Klass Drawer Slide Height 167mm

KSD - 167-23 Loading Capacity 40 kgs



Luxury, Silence, Smooth, Soft closing, Full extension. New safety device to prevent drawer fall out. Heavy-duty, useful life more than 80,000 times. Easy to take drawer out and put it on. Easy for consumer to clear the drawer.

Various sizes and components available to meet different consumer's requirement.

Up & down 4mm adjustable, left & right 3mm adjustable.

Length: 450/ 500 / 550 mm.

Product Information

Space Required

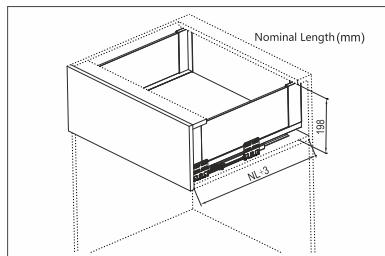

Components View

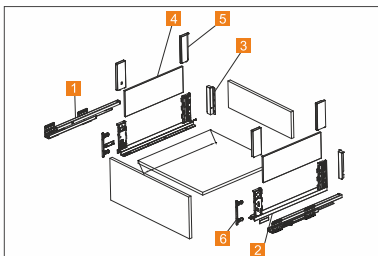

1		Drawer slide L/R
		Loading Capacity 40 Kg
KSD - 167		450 / 500 / 550 mm

2		Decorative Covers L/R
		KSD - 167 - 07
		450 / 500 / 550 mm
Colour		White / Grey

3		Rear Connectors L/R
		FSD - RC - 13
		White / Grey

4		Glass side plates L/R
		KSD - SG - 04 T
		450 / 500 / 550 mm
		450 / 500 / 550 mm
Colour		Transparent / Frosted

KLASS DRAWER

5		Glass fasteners L/R
KSD - SGC-167		White / Grey

6		Front Connectors L/R
FSD - FC - 03		

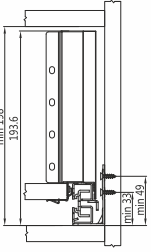
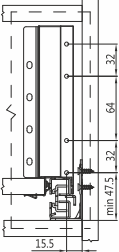
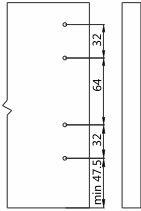
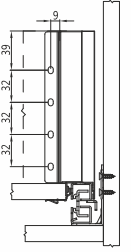
Cabinet Space Requirements 	Front Connectors Panel Mounting dimension 	Inserta & General Panel Mounting hole size 	Mounting Dimensions for the back plate 
--	---	--	--

The drawer runners mounting dimensions

Nominal Length (mm)

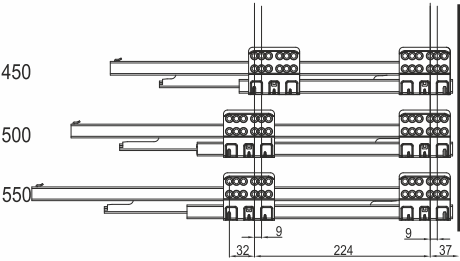

Rail mounting hole distance

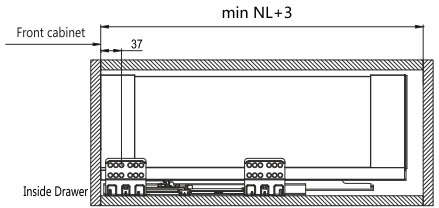

Cutting Dimensions for 16mm - thick MDF

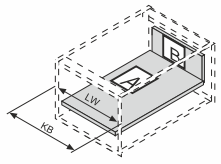
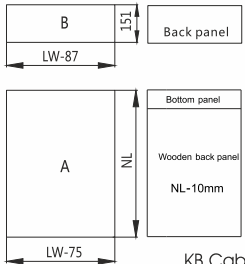

KB Cabinet width
 LW Internal cabinet width
 NL Normal Length

Class Drawer Slide Height 199mm

KSD - 199 - 24 Loading Capacity 40 kgs



Luxury, Silence, Smooth, Soft closing, Full extension. New safety device to prevent drawer fall out. Heavy-duty, useful life more than 80,000 times. Easy to take drawer out and put it on. Easy for consumer to clear the drawer.

Various sizes and components available to meet different consumer's requirement.

Up & down 4mm adjustable, left & right 3mm adjustable.

Length: 450 / 500 / 550 mm.

Product Information

Space Required

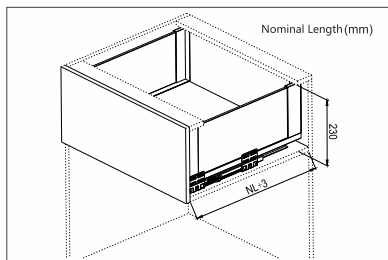

Components View

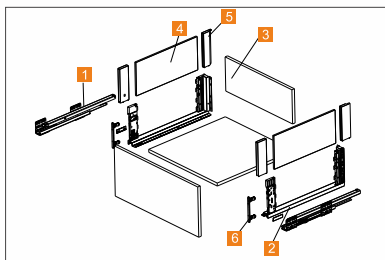

1		Drawer slide L/R
		Loading Capacity 40 Kg
KSD - 199		450 / 500 / 550 mm

2		Decorative Covers L/R
		KSD - 199 - 08
Colour		White / Grey

3		Rear Connectors L/R
		FSD - RC - 14
White / Grey		

4		Glass side plates L/R
		KSD - SG - 05 T
KSD - SG - 05 F		450 / 500 / 550 mm
Colour		Transparent / Frosted

KLASS DRAWER

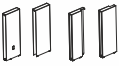
5		Glass fasteners L/R
KSD - SGC - 199	600 / 900 / 1200 mm	
Colour	White / Grey	

6		Inner Drawer Front Connectors L/R
FSD - FC - 04		

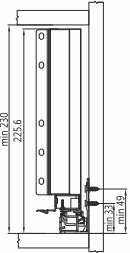
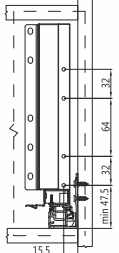
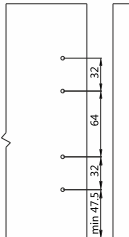
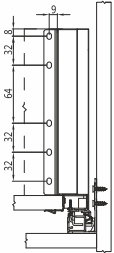
<p>Cabinet Space Requirements</p> 	<p>Front Connectors Panel Mounting dimension</p> 	<p>Inserta & General Panel Mounting hole size</p> 	<p>Mounting Dimensions for the back plate</p> 
--	---	--	--

The drawer runners mounting dimensions

Nominal Length (mm)

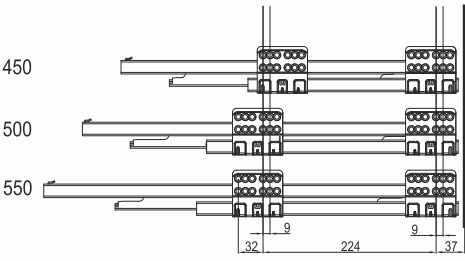

Rail mounting hole distance

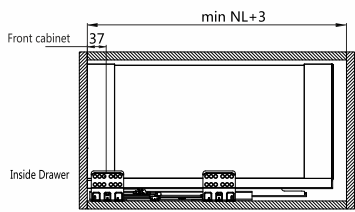

Cutting Dimensions for 16mm - thick MDF

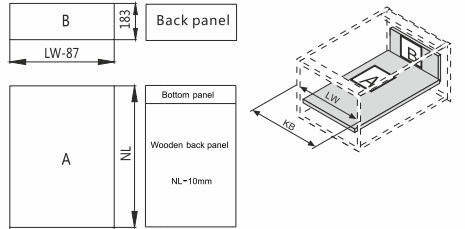

KB Cabinet width
LW Internal cabinet width
NL Normal Length

KLASS DRAWER

Class Drawer Slide With Inner Front Panel & Full Glass Height 84 mm

KISD - 84 - 25 Loading Capacity 40 kgs



Luxury, Silence, Smooth, Soft closing, Full extension. New safety device to prevent drawer fall out. Heavy-duty, useful life more than 80,000 times. Easy to take drawer out and put it on. Easy for consumer to clear the drawer. Various sizes and components available to meet different consumer's requirement. Up & down 4mm adjustable, left & right 3mm adjustable. Length: 450 / 500 / 550 mm.

Product Information

Space Required

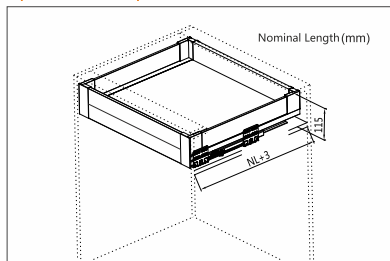

Components View

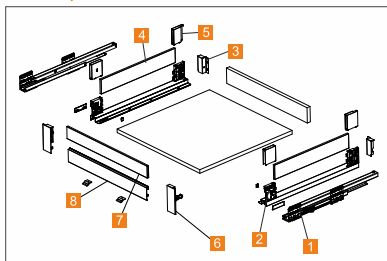

1		Drawer slide L/R
		Loading Capacity 40 Kg
KSD - 84		450 / 500 / 550 mm

2		Decorative Covers L/R
		KSD - 84 - 06
Colour		White / Grey

3		Rear Connectors L/R
		FSD - RC - 11
Colour		White / Grey

4		Glass side plates L/R
		KSD - SG - 03 T
Colour		Transparent / Frosted

KLASS DRAWER

5		Glass fasteners L/R
		KSD - SGC - 84 White / Grey
7		Inner Front Full Glass
		FISD - 84 FG 600 / 900 / 1200 mm
	Colour	White / Grey
6		Inner Drawer Front Connectors L/R
		FISD-FC-84FGP White / Grey
8		Inner Front Panel
		FISD - FP - 01 900 / 1200 mm
	Colour	White / Grey

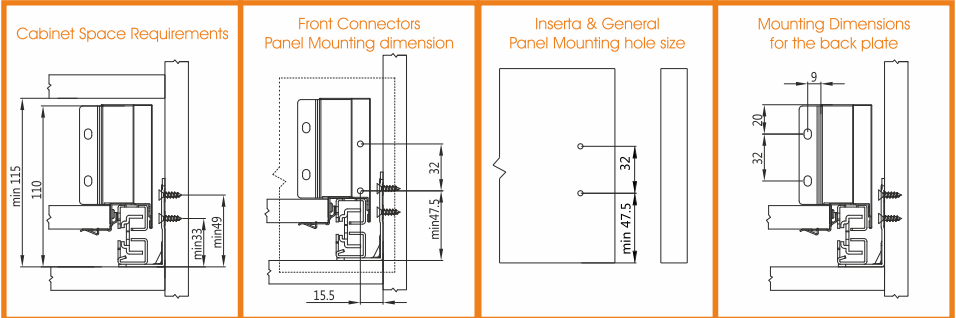

The drawer runners mounting dimensions

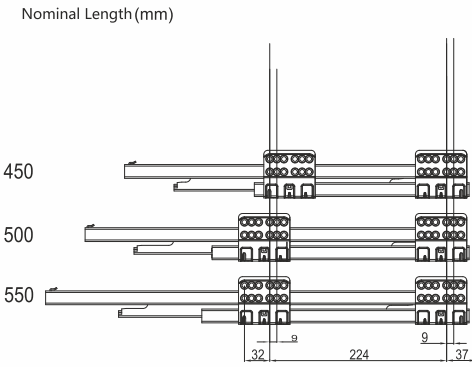

Rail mounting hole distance

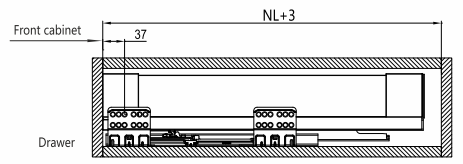

Cutting Dimensions for 16mm - thick MDF

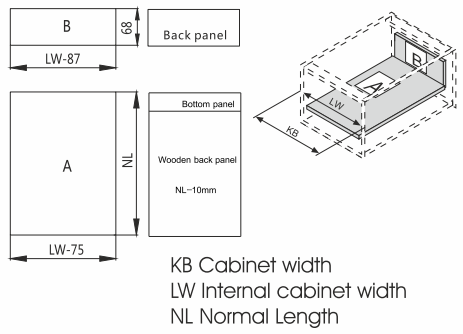

Class Drawer Slide With Inner Front Panel Height 84mm

KISD - 84 - 26 Loading Capacity 40 kgs



Luxury, Silence, Smooth, Soft closing, Full extension. New safety device to prevent drawer fall out. Heavy-duty, useful life more than 80,000 times. Easy to take drawer out and put it on. Easy for consumer to clear the drawer. Various sizes and components available to meet different consumer's requirement. Up & down 4mm adjustable, left & right 3mm adjustable. Length: 450 / 500 / 550 mm.

Product Information

Space Required

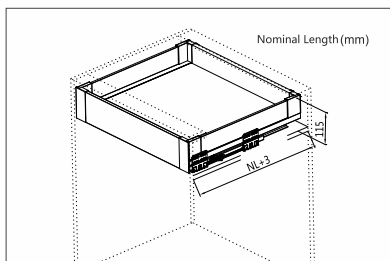

Components View

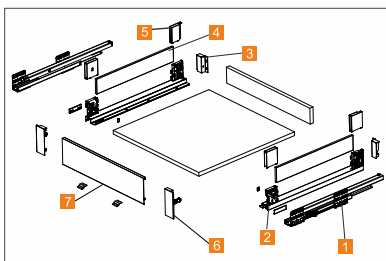



1		Drawer slide L/R
		Loading Capacity 40 Kg
KSD - 84		450 / 500 / 550 mm

3		Rear Connectors L/R
		FSD - RC - 11

2		Decorative Covers L/R
		KSD - 84 - 06
Colour		White / Grey

4		Glass side plates L/R	
		KSD - SG - 03 T	450 / 500 / 550 mm
		KSD - SG - 03 F	450 / 500 / 550 mm
Colour		Transparent / Frosted	

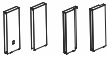
KLASS DRAWER

5		Glass fasteners L/R
KSD - SGC - 84		White / Grey
6		Inner Drawer Front Connectors L/R
FISD - FC - 84P		White / Grey

7		Inner Front Panel
FISD - FP - 01		900 / 1200 mm
Colour		White / Grey

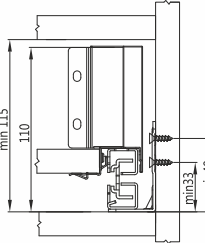
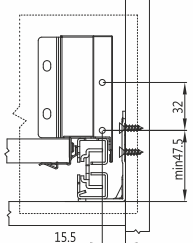
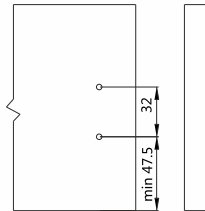
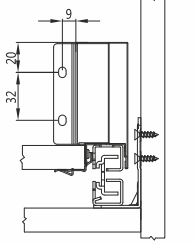
<p>Cabinet Space Requirements</p> 	<p>Front Connectors Panel Mounting dimension</p> 	<p>Inserta & General Panel Mounting hole size</p> 	<p>Mounting Dimensions for the back plate</p> 
---	---	--	--

The drawer runners mounting dimensions

Nominal Length (mm)

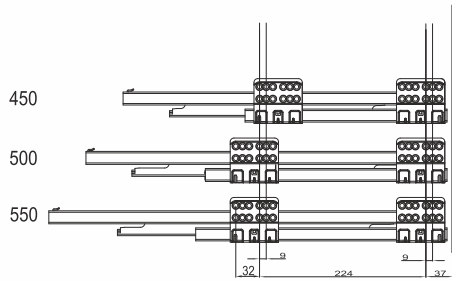

Rail mounting hole distance

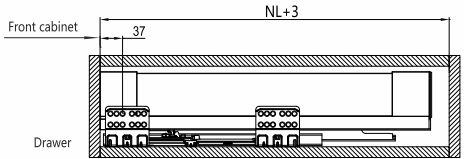

Cutting Dimensions for 16mm - thick MDF

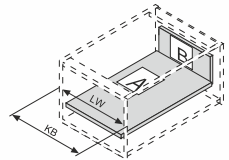
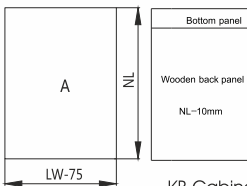
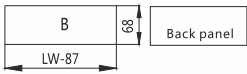

KB Cabinet width
LW Internal cabinet width
NL Normal Length

KLASS DRAWER

Class Drawer Slide With Inner Front Panel & Square bar Height 167mm

KISD - 167 - 27 Loading Capacity 40 kgs



Luxury, Silence, Smooth, Soft closing, Full extension. New safety device to prevent drawer fall out. Heavy- duty, useful life more than 80,000 times. Easy to take drawer out and put it on. Easy for consumer to clear the drawer.

Various sizes and components available to meet different consumer's requirement.

Up & down 4mm adjustable, left & right 3mm adjustable.

Length: 450/ 500 / 550 mm.

Product Information

Space Required

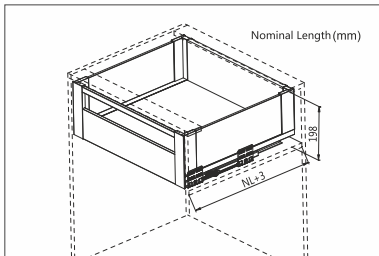

Components View

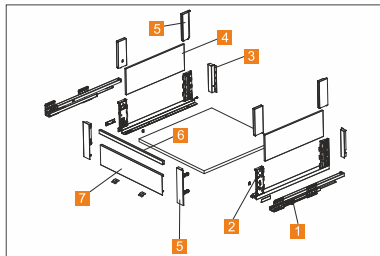

1		Drawer slide L/R
		Loading Capacity 40 Kg
KSD - 167		450 / 500 / 550 mm

2		Decorative Covers L/R
		KSD - 167 - 07
Colour		White / Grey

3		Rear Connectors L/R
		FSD - RC - 13
Colour		White / Grey

4		Glass side plates L/R
		KSD - SG - 04 T
Colour		Transparent / Frosted

KLASS DRAWER

5		Glass fasteners L/R
KSD - SGC-167	White / Grey	

5		Inner Drawer Front Connectors L/R
FISD - FC-167RP	White / Grey	

6		Inner Square Bar
FISD - SB - 01	900 / 1200 mm	
Colour	White / Grey	

7		Inner Front Panel
FISD - FP - 01	900 / 1200 mm	
Colour	White / Grey	

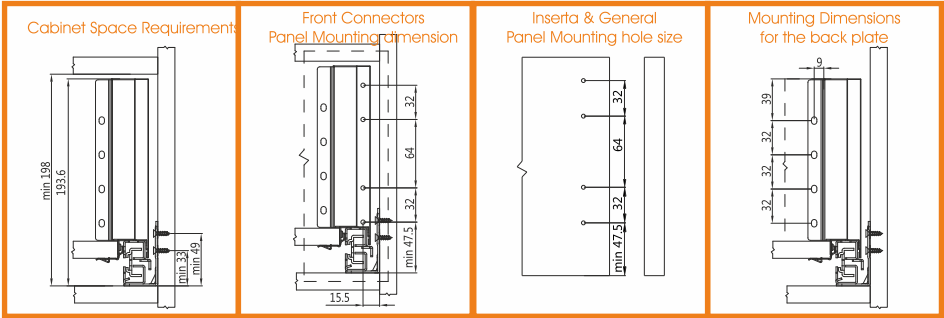

The drawer runners mounting dimensions

Rail mounting hole distance

Nominal Length (mm)

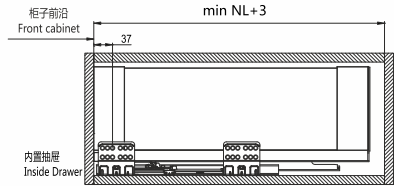
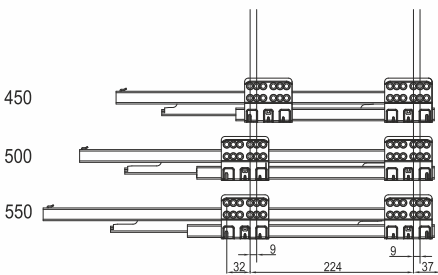

Cutting Dimensions for 16mm - thick MDF

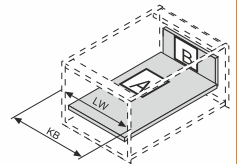
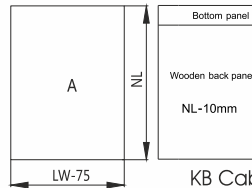
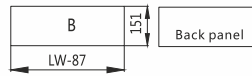

KB Cabinet width
 LW Internal cabinet width
 NL Normal Length

KLASS DRAWER

Class Drawer Slide With Inner Front Panel & Half Glass Height 167mm

KISD - 167 - 28 Loading Capacity 40 kgs



Luxury, Silence, Smooth, Soft closing, Full extension. New safety device to prevent drawer fall out. Heavy-duty, useful life more than 80,000 times. Easy to take drawer out and put it on. Easy for consumer to clear the drawer.

Various sizes and components available to meet different consumer's requirement.

Up & down 4mm adjustable, left & right 3mm adjustable.

Length: 450 / 500 / 550 mm.

Product Information

Space Required

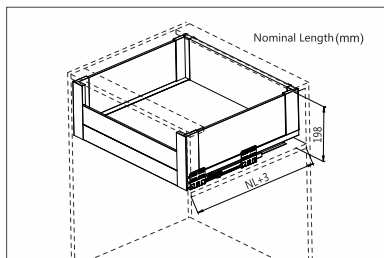

Components View

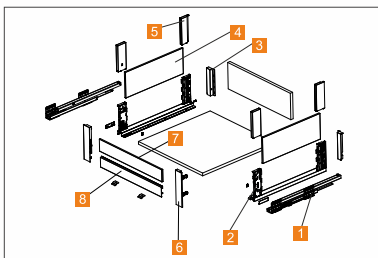

	Drawer slide L/R
	Loading Capacity 40 Kg
KSD - 167	450 / 500 / 550 mm

	Decorative Covers L/R
	KSD - 167-07
Colour	White / Grey

	Rear Connectors L/R
	FSD - RC - 13
Colour	White / Grey

	Glass side plates L/R
	KSD - SG - 04 T
KSD - SG - 04 F	450 / 500 / 550 mm
Colour	Transparent / Frosted

KLASS DRAWER

5		Glass fasteners L/R
KSD - SGC - 167	White / Grey	

6		Inner Drawer Front Connectors L/R
FISD-FC-167-HGP	White / Grey	

7		Inner Front Half Glass
FISD - 167 HG	600 / 900 / 1200 mm	
Colour	Transparent / Frosted	

8		Inner Front Panel
FISD - FP - 02	900 / 1200 mm	
Colour	White / Grey	

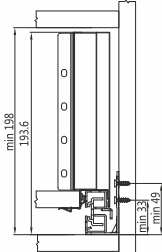
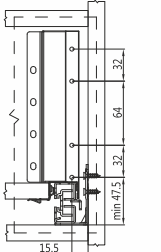
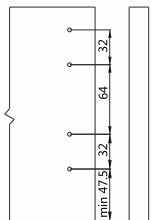
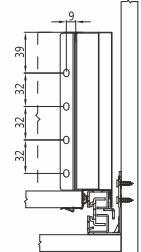
<p>Cabinet Space Requirements</p> 	<p>Front Connectors Panel Mounting dimension</p> 	<p>Inserta & General Panel Mounting hole size</p> 	<p>Mounting Dimensions for the back plate</p> 
--	---	--	--

The drawer runners mounting dimensions

Rail mounting hole distance

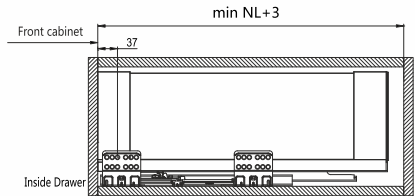
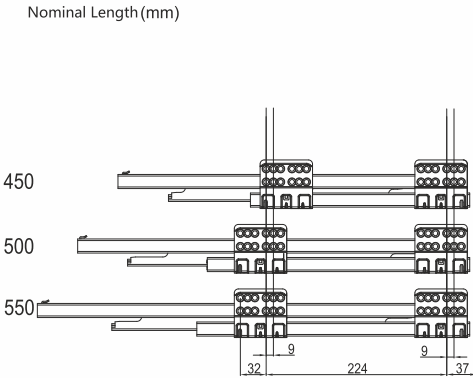

Cutting Dimensions for 16mm - thick MDF

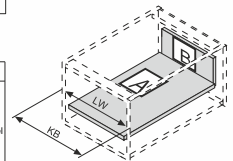
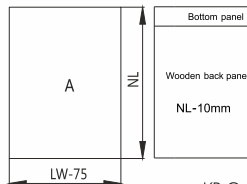
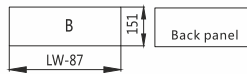

KB Cabinet width
LW Internal cabinet width
NL Normal Length

KLASS DRAWER

Class Drawer Slide With Inner Front Panel & Full Glass Height 167mm

KISD-167-29 Loading Capacity 40 kgs



Luxury, Silence, Smooth, Soft closing, Full extension. New safety device to prevent drawer fall out. Heavy-duty, useful life more than 80,000 times. Easy to take drawer out and put it on. Easy for consumer to clear the drawer.

Various sizes and components available to meet different consumer's requirement.

Up & down 4mm adjustable, left & right 3mm adjustable.

Length: 450/ 500 / 550 mm.

Product Information

Space Required

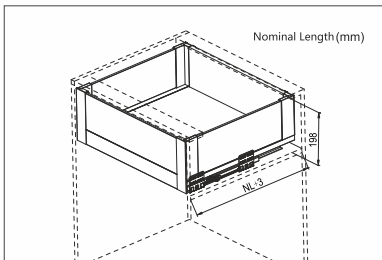

Components View

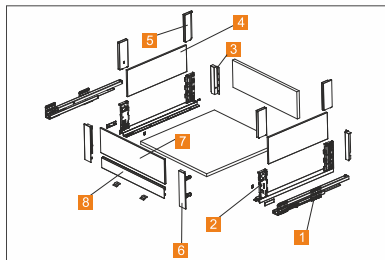

1		Drawer slide L/R
		Loading Capacity 40 Kg
KSD - 167		450 / 500 / 550 mm

2		Decorative Covers L/R
KSD - 167-07		450 / 500 / 550 mm
Colour		White / Grey

3		Rear Connectors L/R
FSD - RC - 13		White / Grey

4		Glass side plates L/R
KSD - SG - 04 T		450 / 500 / 550 mm
KSD - SG - 04 F		450 / 500 / 550 mm
Colour		Transparent / Frosted

KLASS DRAWER

5		Glass fasteners L/R
KSD - SGC-167	White / Grey	

6		Inner Drawer Front Connectors L/R
FISD-FC-167-FGP	White / Grey	

7		Inner Front Full Glass
FISD - 167 FG	600 / 900 / 1200 mm	
Colour	Transparent / Frosted	

8		Inner Front Panel
FISD - FP - 02	900 / 1200 mm	
Colour	White / Grey	

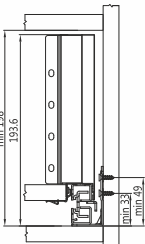
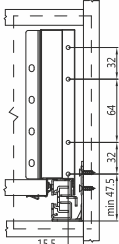
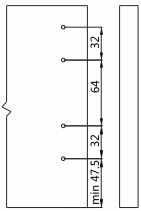
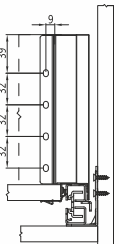
Cabinet Space Requirements	Front Connectors Panel Mounting dimension	Inserta & General Panel Mounting hole size	Mounting Dimensions for the back plate
			

The drawer runners mounting dimensions

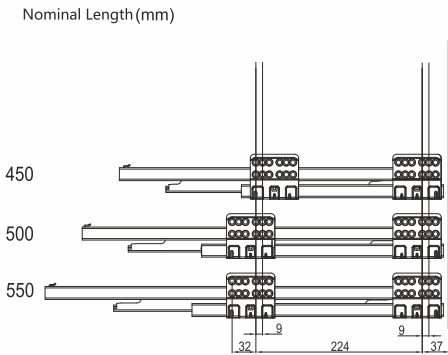

Rail mounting hole distance

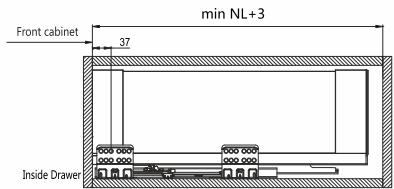

Cutting Dimensions for 16mm - thick MDF

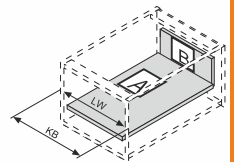
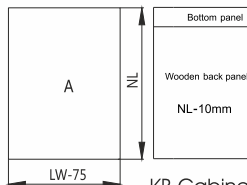
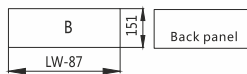

KB Cabinet width
LW Internal cabinet width
NL Normal Length

KLASS DRAWER

Klass Drawer Slide With Inner Front Panel & Square bar Height 199mm

KISD - 199 - 30 Loading Capacity 40 kgs



Luxury, Silence, Smooth, Soft closing, Full extension. New safety device to prevent drawer fall out. Heavy- duty, useful life more than 80,000 times. Easy to take drawer out and put it on. Easy for consumer to clear the drawer.

Various sizes and components available to meet different consumer's requirement.

Up & down 4mm adjustable, left & right 3mm adjustable.

Length: 450 / 500 / 550 mm.

Product Information

Space Required

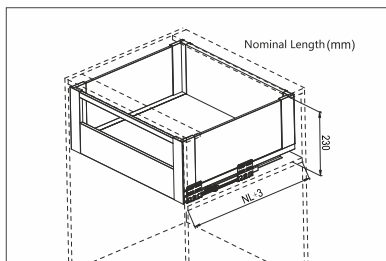

Components View

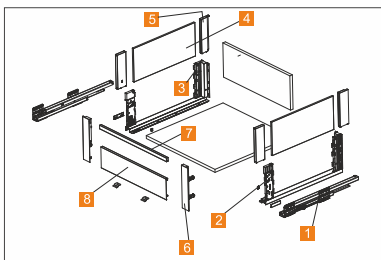

1		Drawer slide L/R
	KSD - 199	Loading Capacity 40 Kg 450 / 500 / 550 mm

2		Decorative Covers L/R
	KSD - 199-08	450 / 500 / 550 mm Colour White / Grey

3		Rear Connectors L/R
	FSD - RC - 14	White / Grey

4		Glass side plates L/R
	KSD - SG - 05 T	450 / 500 / 550 mm
	KSD - SG - 05 F	450 / 500 / 550 mm
	Colour	Transparent / Frosted

KLASS DRAWER

5		Glass fasteners L/R
KSD - SGC-199	White / Grey	

7		Inner Square Bar
FISD - SB - 01	900 / 1200 mm	
Colour	White / Grey	

6		Inner Drawer Front Connectors L/R
FISD-FC-199 RP	White / Grey	

8		Inner Front Panel
FISD - FP - 01	900 / 1200 mm	
Colour	White / Grey	

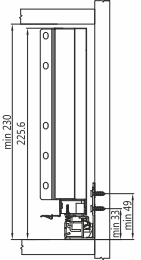
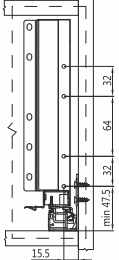
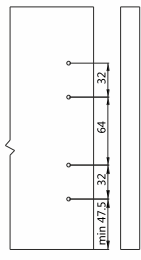
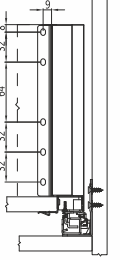
<p>Cabinet Space Requirements</p> 	<p>Front Connectors Panel Mounting dimension</p> 	<p>Inserta & General Panel Mounting hole size</p> 	<p>Mounting Dimensions for the back plate</p> 
---	--	---	---

The drawer runners mounting dimensions

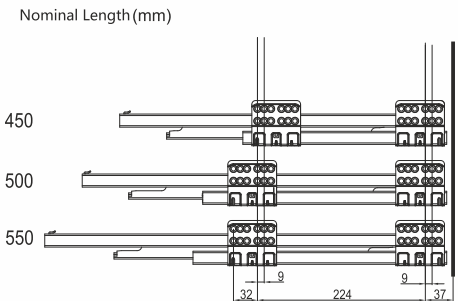

Rail mounting hole distance

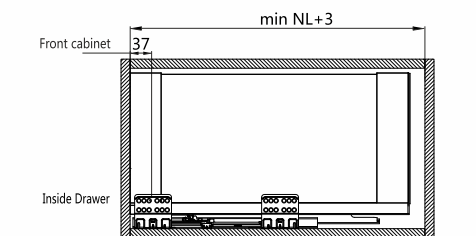

Cutting Dimensions for 16mm - thick MDF

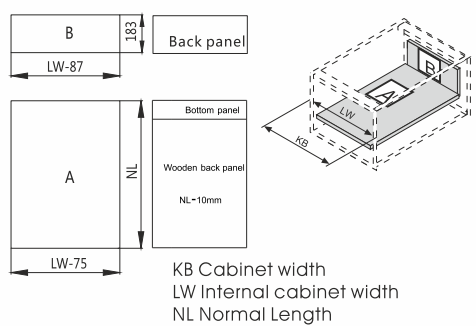

Klass Drawer Slide With Inner Front Panel & Half Glass Height 199mm

KSD - 199 - 31 Loading Capacity 40 kgs



Luxury, Silence, Smooth, Soft closing, Full extension. New safety device to prevent drawer fall out. Heavy-duty, useful life more than 80,000 times. Easy to take drawer out and put it on. Easy for consumer to clear the drawer.

Various sizes and components available to meet different consumer's requirement.

Up & down 4mm adjustable, left & right 3mm adjustable.

Length: 450/ 500 / 550 mm.

Product Information

Space Required

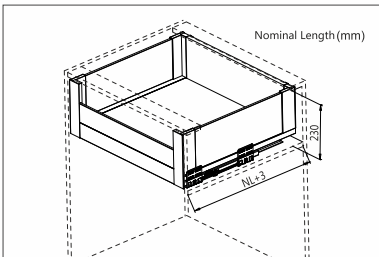

Components View

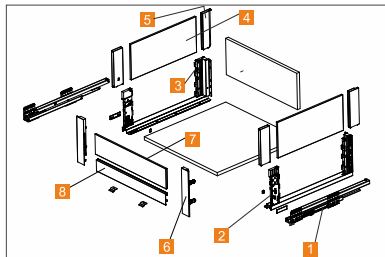

1		Drawer slide L/R
		Loading Capacity 40 Kg
	KSD - 199	450 / 500 / 550 mm

2		Decorative Covers L/R
		KSD - 199-08
	Colour	White / Grey
		450 / 500 / 550 mm

3		Rear Connectors L/R
		FSD - RC - 14
	Colour	White / Grey

4		Glass side plates L/R
		KSD - SG - 05 T
	KSD - SG - 05 F	450 / 500 / 550 mm
	Colour	Transparent / Frosted

KLASS DRAWER

5		Glass fasteners L/R
KSD - SGC-199	White / Grey	

6		Inner Drawer Front Connectors L/R
FISD-FC-199 HGP	White / Grey	

7		Inner Front Half Glass
FISD - 199 HG	600 / 900 / 1200 mm	
Colour	Transparent / Frosted	

8		Inner front Panel
FISD - FP - 02	900 / 1200 mm	
Colour	White / Grey	

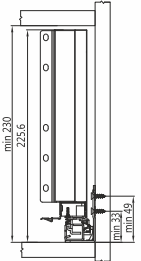
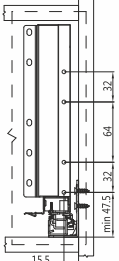
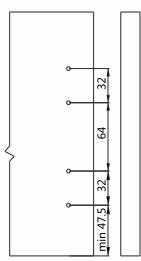
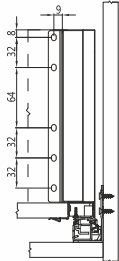
<p>Cabinet Space Requirements</p> 	<p>Front Connectors Panel Mounting dimension</p> 	<p>Inserts & General Panel Mounting hole size</p> 	<p>Mounting Dimensions for the back plate</p> 
--	---	--	--

Drawer runners mounting dimensions

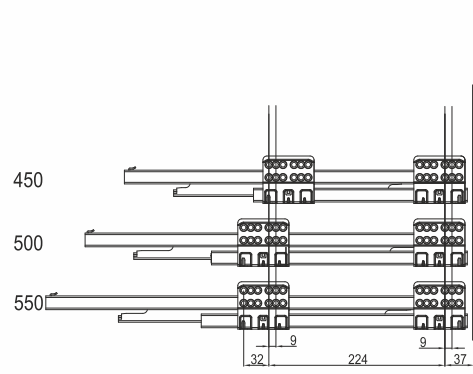

Rail mounting hole distance

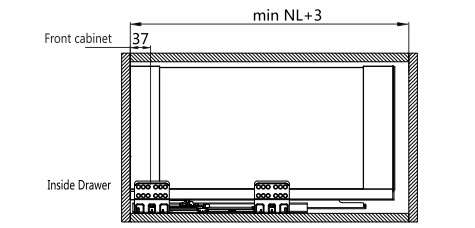

Cutting Dimensions for 16mm - thick MDF

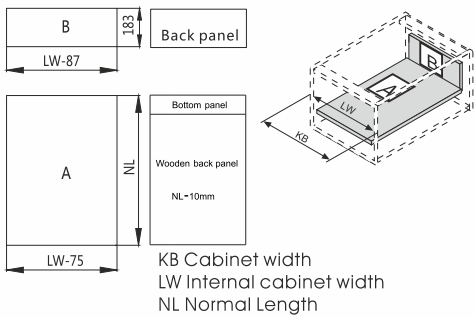

KLASS DRAWER

Klass Drawer Slide With Inner Front Panel & Full Glass Height 199mm

KISD - 199 - 32 Loading Capacity 40 kgs



Luxury, Silence, Smooth, Soft closing, Full extension. New safety device to prevent drawer fall out. Heavy-duty, useful life more than 80,000 times. Easy to take drawer out and put it on. Easy for consumer to clear the drawer.

Various sizes and components available to meet different consumer's requirement.

Up & down 4mm adjustable, left & right 3mm adjustable.

Length: 450 / 500 / 550 mm.

Product Information

Space Required

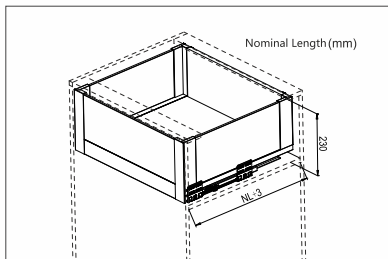

Components View

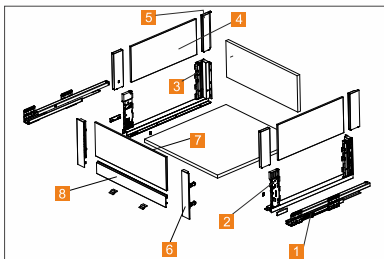

1		Drawer slide L/R
		Loading Capacity 40 Kg
	KSD - 199	450 / 500 / 550 mm

2		Decorative Covers L/R
		450 / 500 / 550 mm
	KSD - 199-08	450 / 500 / 550 mm
	Colour	White / Grey

3		Rear Connectors L/R
		White / Grey
	FSD - RC - 14	White / Grey

4		Glass side plates L/R
		450 / 500 / 550 mm
	KSD - SG - 05 T	450 / 500 / 550 mm
	KSD - SG - 05 F	450 / 500 / 550 mm
	Colour	Transparent / Frosted

KLASS DRAWER

5		Glass fasteners L/R
KSD - SGC-199	White / Grey	

6		Inner Drawer Front Connectors L/R
FISD-FC-199-FGP	White / Grey	

7		Inner Front Full Glass
FISD - 199 FG	600 / 900 / 1200 mm	
Colour	Transparent / Frosted	

8		Inner Front Panel
FISD - FP - 02	900 / 1200 mm	
Colour	White / Grey	

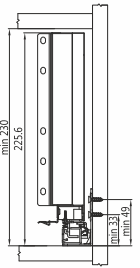
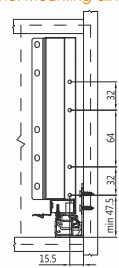
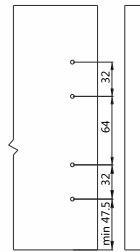
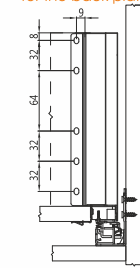
Cabinet Space Requirements 	Front Connectors Panel Mounting dimension 	Inserts & General Panel Mounting hole size 	Mounting Dimensions for the back plate 
--	---	--	--

The drawer runners mounting dimensions

Nominal length (mm)

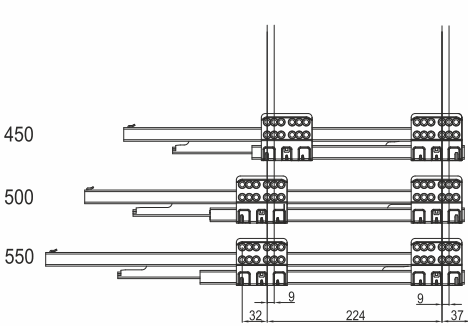

Rail mounting hole distance

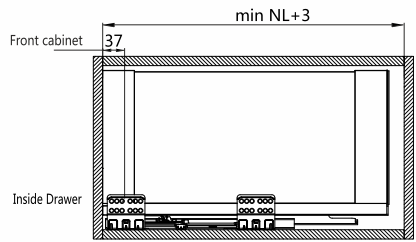

Cutting Dimensions for 16mm - thick MDF

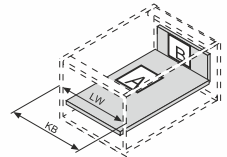
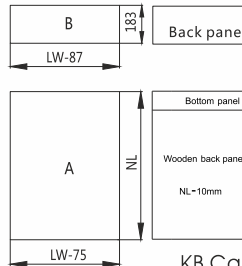

KB Cabinet width
LW Internal cabinet width
NL Normal Length

→ BASIC COMPONENTS

→ INSTALL, DISASSEMBLY AND REGULATION

Class Drawer Height 84 mm

Install the drawer

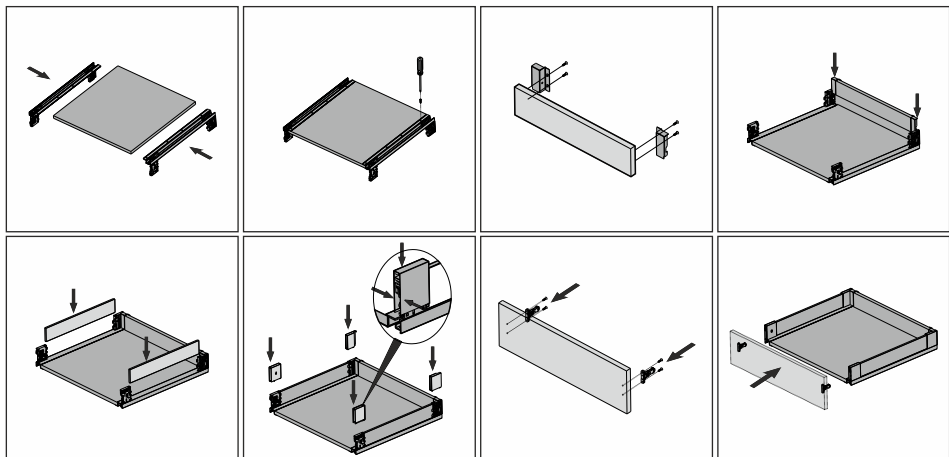

Adjustment

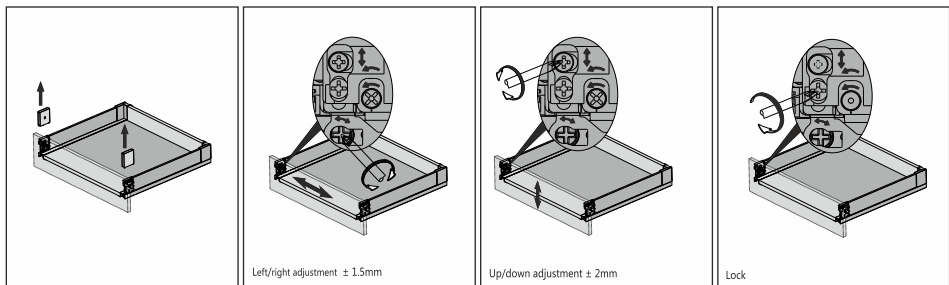

Remove the panel

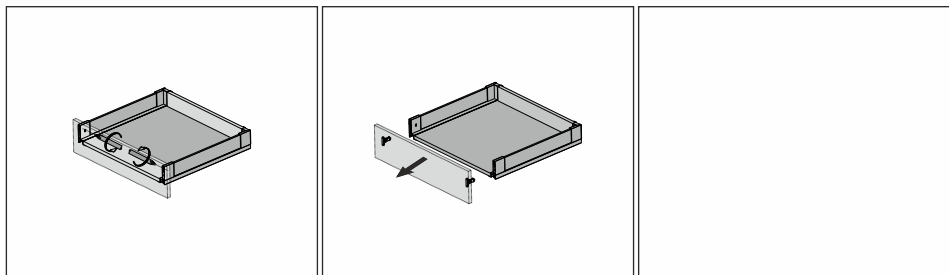

KLASS DRAWER

→ BASIC COMPONENTS

→ INSTALL, DISASSEMBLY AND REGULATION

Install the drawer

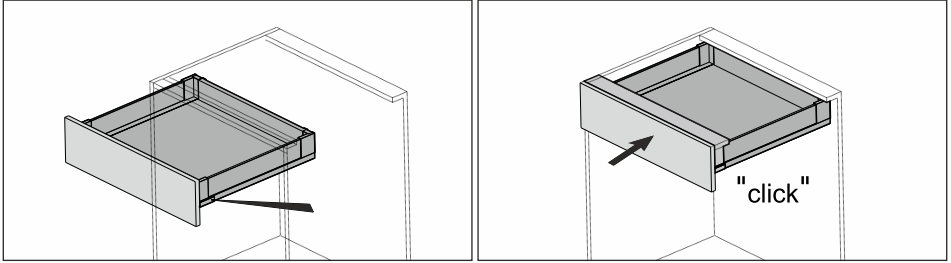

Remove the drawer

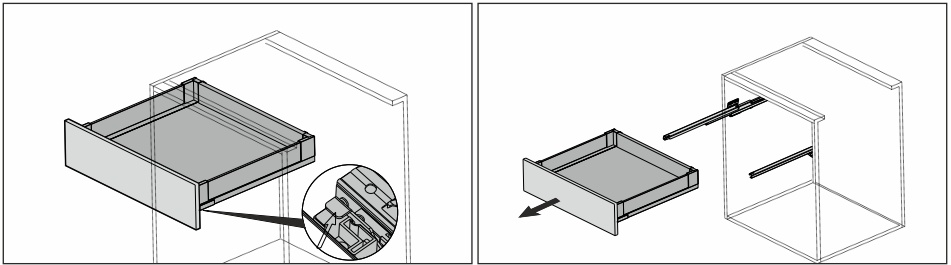

Klass inner drawer Height 84 mm

Install the inner front panel

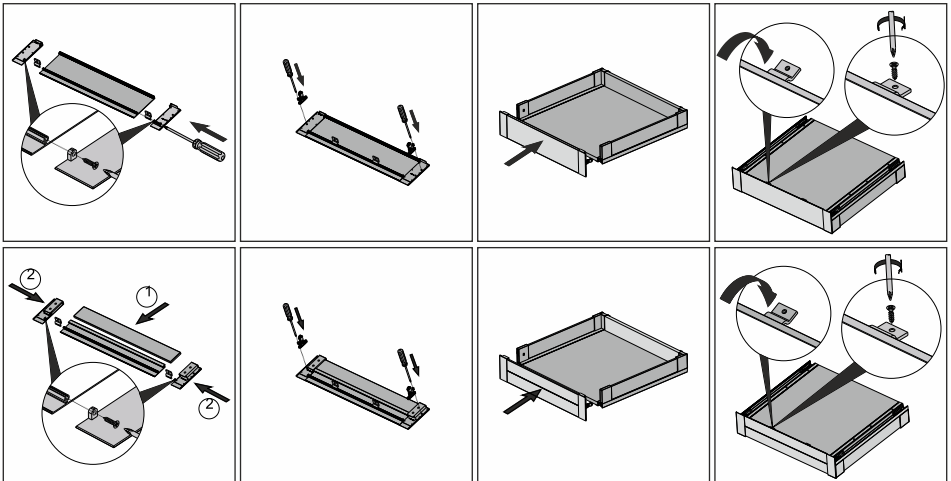

→ BASIC COMPONENTS

→ INSTALL, DISASSEMBLY AND REGULATION

Class Drawer Height 167 & 199 mm

Install the drawer

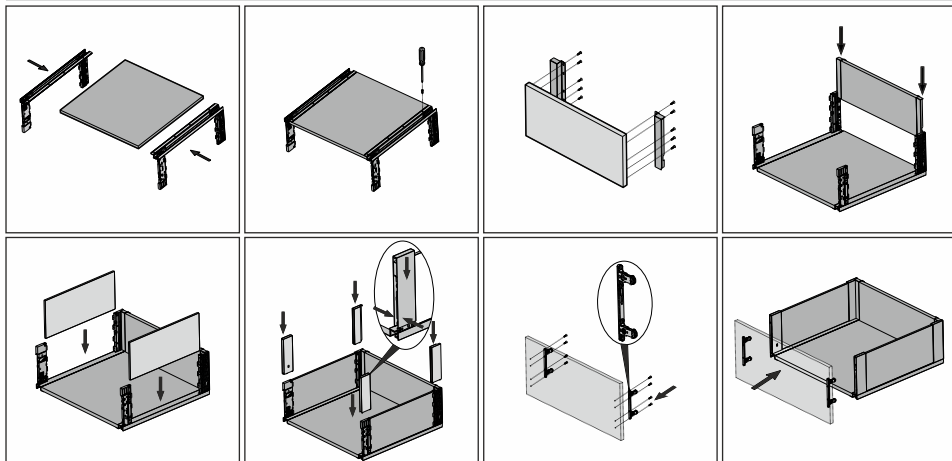

Adjustment

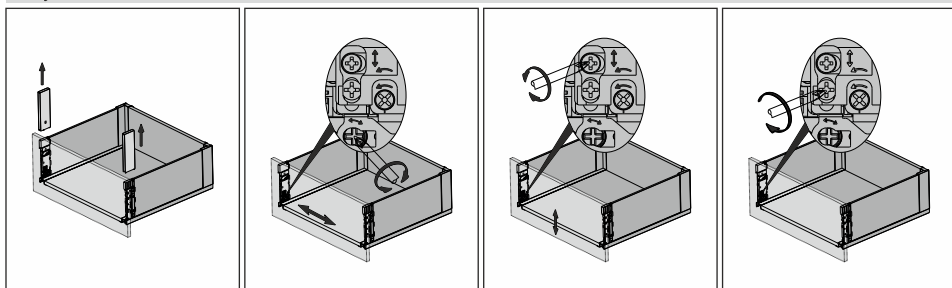

Remove the panel

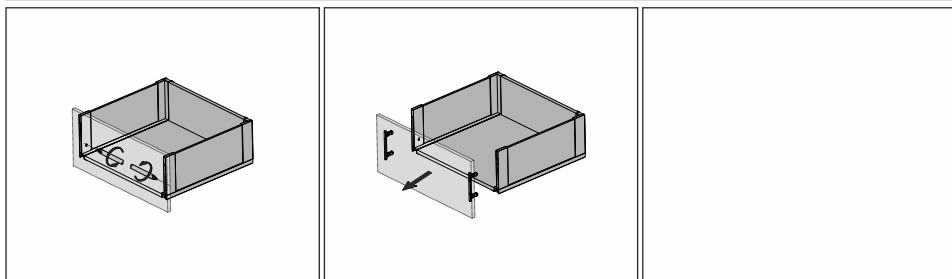

KLASS DRAWER

→ BASIC COMPONENTS

→ INSTALL, DISASSEMBLY AND REGULATION

Install the drawer

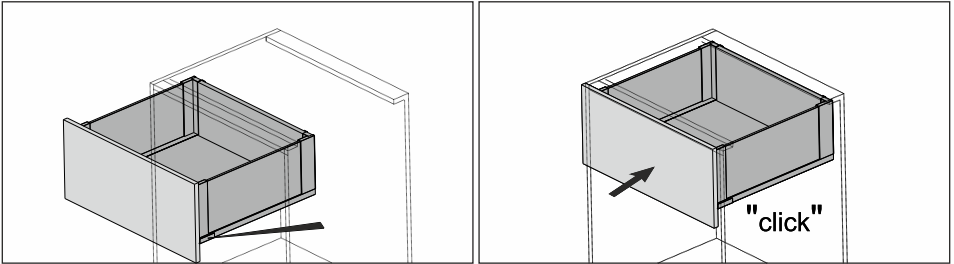

Remove the drawer

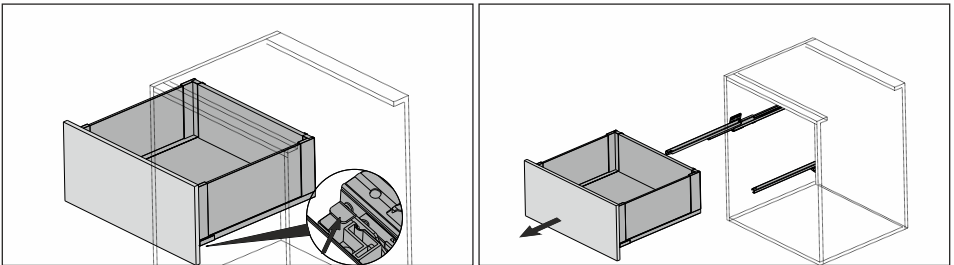

Klass inner drawer Height 167 & 199 mm

Install the inner front panel with bar

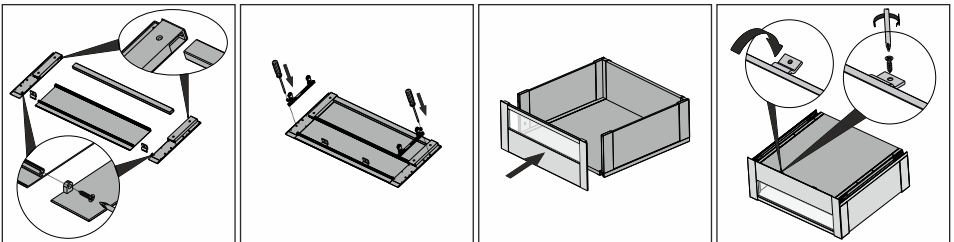

Install the inner front panel with glass

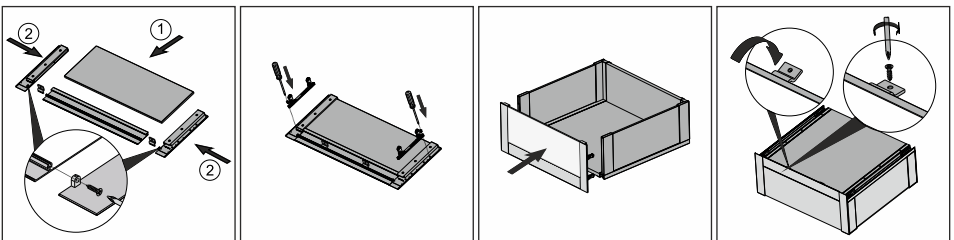

Tandem Divider Partition for height 151mm & 183mm

FTB-DW



Product Information

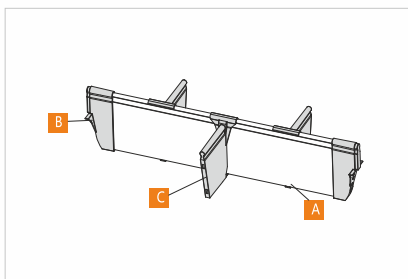

A		Divider Partition Panel
FTB -DW- DPP	900 / 1200 mm	
Colour	White / Grey	
B		Divider Side Couplings
FTB -DW- DSC	White / Grey	
C		Divider Partition Riser
FTB -DW- DPR	White / Grey	

KB Cabinet width	drawer nominal length	
	500mm	550mm
400mm	2PCS-A + 4PCS-B + 4PCS-C	4PCS-C
450mm		
500mm	2PCS-A + 4PCS-B + 4PCS-C	4PCS-C
600mm		
750mm		
800 mm	2PCS-A + 4PCS-B + 6PCS-C	6PCS-C
900mm		
1000mm	2PCS-A + 4PCS-B + 8PCS-C	8PCS-C
1200mm		

PLATE HOLDER



Product Information

	F - PHG
Width & Disk Numbers	400 - 600 mm – 2 pieces
	700 - 800 mm – 4 pieces
	1000 - 1200 mm – 6 pieces

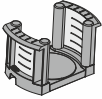
	
The diameter of the disk	180-320mm
The total height	170mm
The plate stack height	145mm

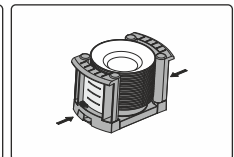
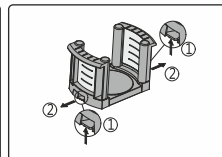
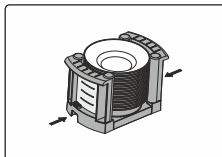
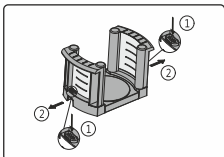
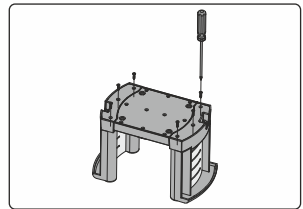
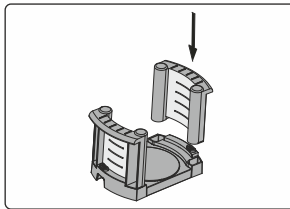
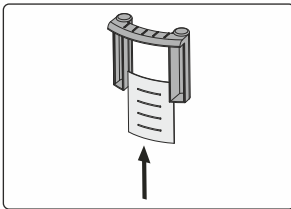

SS Box Cutlery



Product Information

B

F - CUT - 500B 500 mm

C

F - CUT - 500C 500 mm

G

F - CUT - 500G 500 mm

I

F - CUT - 500I 500 mm

F

F - CUT - 500 F 500 mm

Connector for Trays

F - CUT - PA 122 x 150 mm

Product Information

cupboard width: 270/300mm



Nominal Length	
500 mm	1 x F - CUT 500B

cupboard width: 300/350mm



Nominal Length	
500 mm	2 x F - CUT 500B

cupboard width: 400/450/500mm



Nominal Length	
500 mm	1 x F - CUT 500C

cupboard width: 600mm



Choose
F - CUT - PA

500 mm	1 X F - CUT 500C + 1 X F - CUT 500B
--------	---

cupboard width: 700mm



Choose
F - CUT - PA

Nominal Length	
500 mm	1 X F - CUT 500C + 1 X F - CUT 500G

cupboard width: 800mm



Choose
F - CUT - PA

Nominal Length	
500 mm	2 x F - CUT 500C

cupboard width: 900/1000mm



Choose
F - CUT - PA

Nominal Length	
500 mm	1 X F - CUT 500I + 1 X F - CUT 500C

cupboard width : 600 mm



Nominal Length	
500 mm	1 X F - CUT 500F

cupboard width : 800 mm



Nominal Length	
500 mm	1 X F - CUT - 500G + 1 X F - CUT - 500F

PVC Cutlery



Product Information



	W 390 x D 490 x H 45 mm
F - PCT - 450	500 mm

	W 840 x D 490 x H 45 mm
F - PCT - 600	500 mm

	W 540x D 490 x H 45 mm
F - PCT - 900	500 mm

ANTI SKID MAT



Product Information

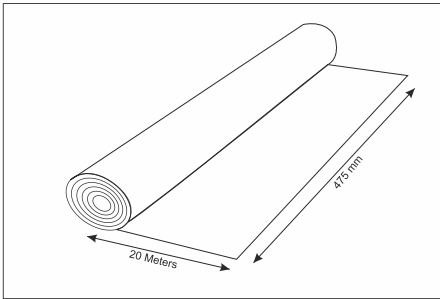

	W 0.48 Mtr x D 20 Mtr
F - ASM	

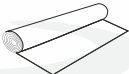
	W 0.48 Mtr x D 1Mtr
F - ASM	

FBQ - 500



Product Information

Space Required

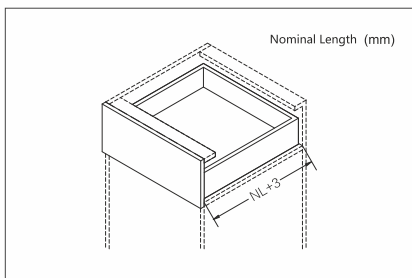
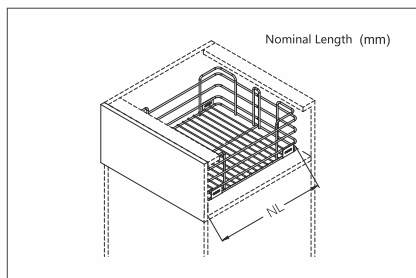

Component View

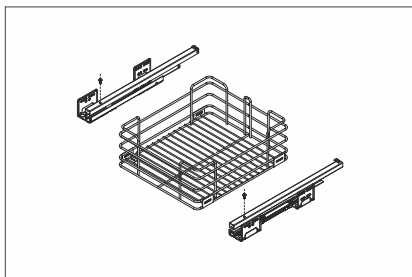
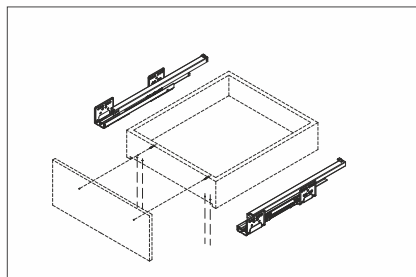



SIZE	0°	8°	16°
PRODUCT CODE	F3DSC-1	F3DSC-2	F3DSC-3

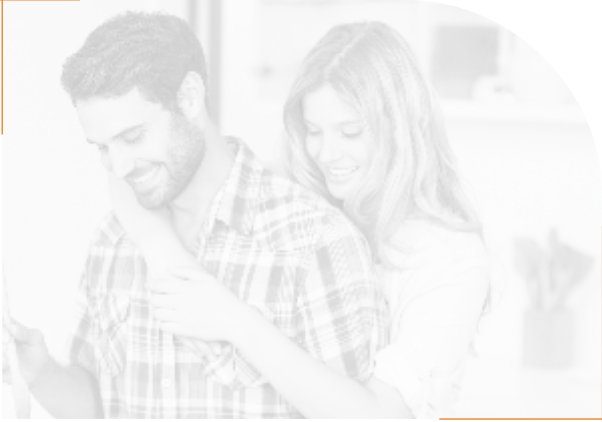

Modular Kitchen Accessories

Hardware & Fittings

Registered & Head office :

FEDER INDIA

 8 CENTER POINT, INDIRA GANDHI MARG
NEAR CELEBRATION HOTEL,
JAMNAGAR - 361008
GUJARAT

Hyderabad office :

FEDER INDIA

 B-1, CENTRAL WAREHOUSING SADAN,
BEHIND GANDHI BHAVAN, NAMPALLY,
HYDERABAD - 500001
TALANGANA

 EMAIL : INFO@FEDERINDIA.COM

 WWW.FEDERINDIA.COM

